

Carlisle...Your Global Resource

Today, more than ever, it is imperative that suppliers are prepared to support their customers around the world. Carlisle Brake & Friction has established a network of manufacturing and distribution facilities around the globe that give us a presence in the world's fastest growing markets. This commitment to the global marketplace makes Carlisle the right choice for your new brake or friction design, no matter where you are or what you want to be.



ASIAN PACIFIC

**Carlisle Brake & Friction
Headquarters AP
[Suzhou]**
65 Huaju Road Suzhou New District
Suzhou, China 215009
Phone: 0086 512 6808 1808

**Carlisle Brake & Friction
[Hangzhou]**
Industry Zone, Tangxi Town, Yuhang
District Hangzhou, 311106, P.R. of China
Phone: 0086 571 8631 9078
Fax: 0086 571 8631 8567

Japan Power Brake
2453-9 Aze-dainooka, Iiyama
Atsugi-shi, Kanagawa-ken
243-02, Japan
Phone: 0081 46 247 7564
Fax: 0081 46 247 0582

**Carlisle Brake & Friction
[India]**
Regus Olympia Tech park Level
2, Altus, 1-SIDCO Industrial Estate,
Guindy, Chennai-600 032, Tamil
Nadu, India.
Phone: 0091 44 4299 4351
Fax: 0091 44 4299 4300

NORTH AMERICA

**Carlisle Brake & Friction World
Headquarters**
6180 Cochran Road Solon,
OH 44139, USA
Phone: 001 440 528 4000
FAX: 001 440 528 4099
Email: sales@carlislecbf.com

SOUTH AMERICA

**Carlisle Brake & Friction
Sales Office Contact**
Phone: 0054 911 5955 3857
(discando desde fuera de Argentina)
Phone: 011 15 5955 3857
(discando dentro de Argentina)

EUROPEAN SALES OFFICES

Carlisle Brake & Friction IT
Via Pacinotti 9 Orzinuovi, Italy
Phone: 0039 030 9942825
Fax: 0039 030 942768

Carlisle Brake & Friction U.K
Omega 500 Unit Mamhilad
Technology Park Pontypool-NP4 0JJ
United Kingdom
Phone: 0044(0)1495 767308
Fax: 0044(0)1495 767340

**Carlisle Brake & Friction
[Australia & New Zealand]**
Sales Office Contact
Phone: 0061 40 010 2772



EXPERIENCED. GLOBAL. INNOVATIVE.

CARLISLE BRAKE & FRICTION CATALOGUE



HYDRAULIC CONTROLS

FRICTION COMPONENTS

CLUTCH ASSEMBLIES

TRANSMISSION DISCS

BRAKE SYSTEMS

TABLE OF CONTENTS

ABOUT US

Overview	01
Company Culture	02
Product Solutions	03
Markets	04
Manufacturing Excellence	05
Research & Development	06

PRODUCTS

Service Brakes	11
Park Brakes	22
Combo Brakes	31
Hydraulic Control	33
Booster	44
Wet Friction	51
New Products Development	62

MINING

Carlisle Brake & Friction (CBF) has been the brake supplier of choice in the mining industry for decades, counting the world's largest and most respected mining OEMs as customers. CBF first started supplying braking products to the mining industry in the 1930s at the onset of off-highway vehicle manufacturing. Over the past seventy years CBF has established itself as the undisputed industry leader in dry brake system and friction solutions. Recently the evolution of large scale wet braking systems has created a technology shift in the industry. CBF met the challenge and developed high density paper and carbon paper friction discs that provided OEMs unparalleled performance and durability. CBF consistently remains in the braking technology forefront by adapting to the changes in the industry, expanding the technology envelope and ultimately providing superior solutions to world class OEMs around the world.

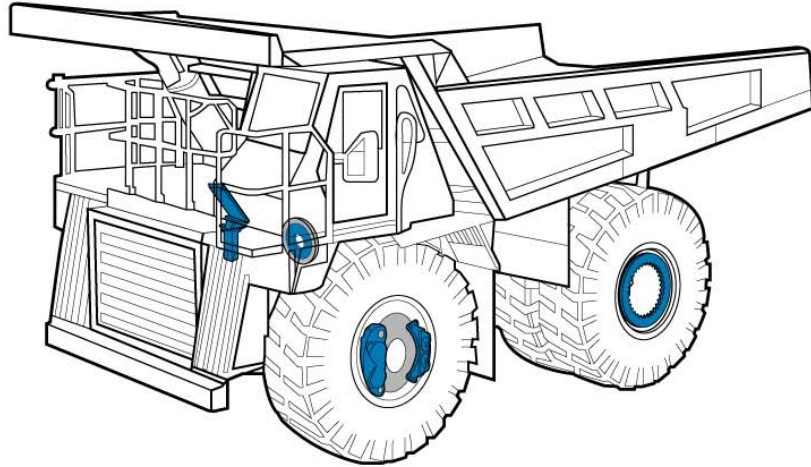

CONSTRUCTION

The construction machine market has been a cornerstone of Carlisle Brake & Friction (CBF) for decades. Our products are used by the most recognized construction OEMs in the world in applications around the globe as diverse as articulated dump trucks to backhoe loaders. We designed the first caliper disc brakes in the 1950s. In 1975 we introduced high density paper friction discs for the emerging wet brake system technology. Today CBF offers a wide range of motion control solutions including complete hydraulic brake systems and superior frictions material components for wet brake, dry brake, clutch and transmission applications. If you pass a construction site during your day, chances are you've seen a vehicle with a CBF product on it.

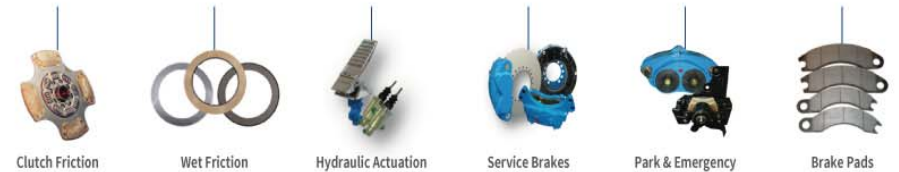
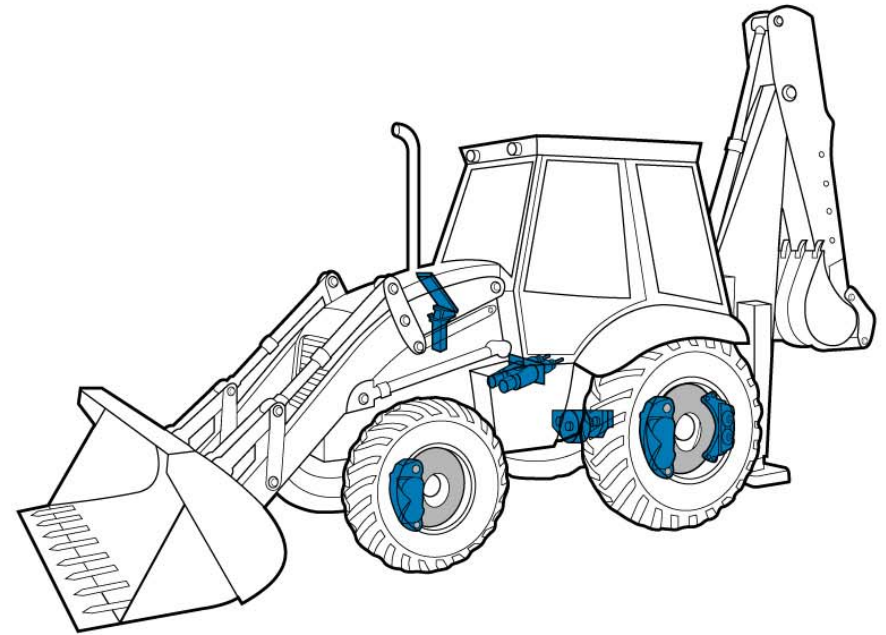

AGRICULTURE

Carlisle Brake & Friction (CBF) has been a significant brake system and friction component supplier to agriculture and forestry industry for over thirty years. Our customer base is an extensive list of industry leaders. Our friction components are utilized in countless clutch, transmission, wet brake and dry brake applications. We also expanded our brake system capabilities with the acquisition of ArvinMeritor's off-highway braking division in 2005 (formerly Lucas Girling). Today, our master cylinders, boosted master cylinders, ball and ramp brakes, and friction components are hard at work in agricultural equipment all over the world.

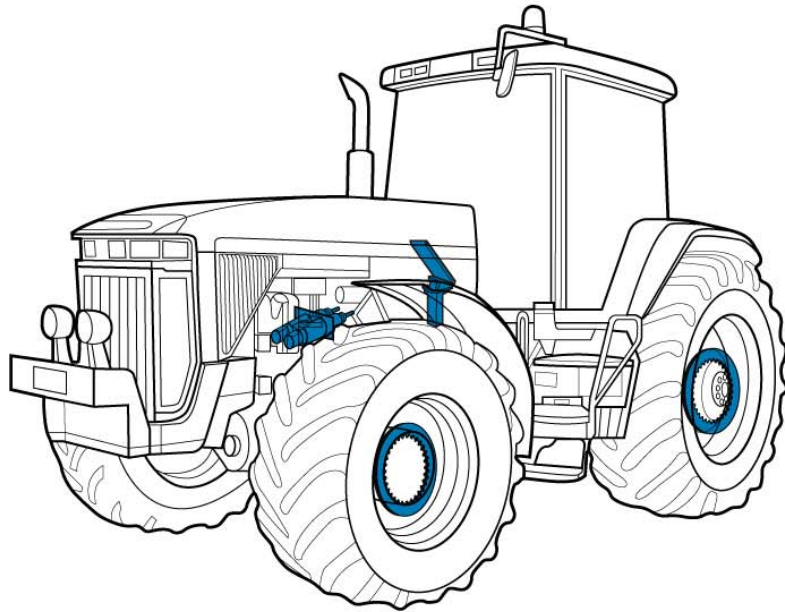

INDUSTRIAL

Carlisle Brake & Friction (CBF) has been supplying braking systems and friction components to original equipment manufacturers in a diverse range of industrial markets for over 87 years. Our products can be found on material handling vehicles, oil rigs, telehandlers, transit systems, car and truck commercial fleets, cranes, elevators, amusement park rides, motorcycles, ATVs, snowmobiles, and electromagnetic devices. CBF provides our customers, with reliable and often revolutionary solutions for dynamic and static motion control applications.

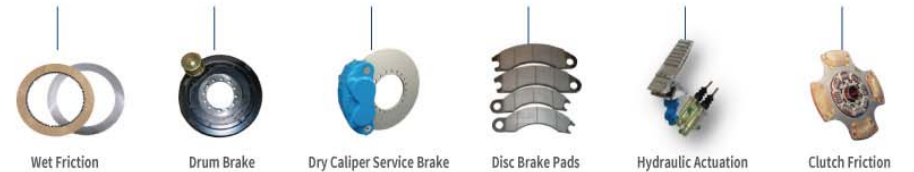
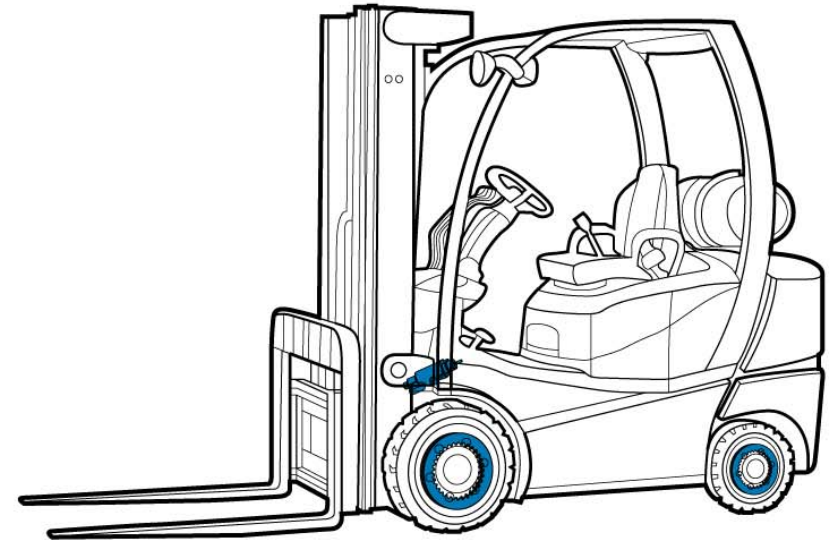

SERVICE BRAKES

- 12 F4/FF4 SERIES SERVICE BRAKES
- 13 FF6 SERVICE BRAKE
- 14 J6 SERVICE BRAKE
- 15 M6-25 SERVICE BRAKE
- 16 M6-29 SERVICE BRAKE
- 17 M4 SERVICE BRAKE
- 18 PD1425 SERVICE BRAKE
- 19 SCL2 SERVICE BRAKE
- 20 SCL56 SERVICE BRAKE
- 21 MMK2 SERIES
- QUESTIONNAIRE



F4/FF4 SERIES SERVICE BRAKES

Description

The Carlisle F4 and FF4 series brakes are hydraulically actuated, four-piston, disc brakes with retracting springs and automatic adjusters. These brakes are typically bolted to the armature shaft of an electric wheel motor equipped with either a 20" or 25" diameter disc.

FEATURES

- Piston housings constructed from ductile iron casting for superior brake durability
- Equipped with Carlisle premium asbestos-free linings, providing superior stopping performance and life
- Optional seal materials available for compatibility with all actuation fluids and temperatures
- Modular piston design for easy serviceability
- Piston insulators are standard to protect brake components from heat transfer

APPLICATION

- Electric drive surface mining haulage trucks
- Earth-moving equipment
- Mining equipment
- Industrial equipment

Specifications

	F4-20	F4-25	FF4-25
Caliper Material	Steel and ductile iron	Steel and ductile iron	Steel and ductile iron
Mounting Attitude	Any position	Any position	Any position
Maximum Pressure	1,500 psi (103.4 bar)	1,500 psi (103.4 bar)	2,000 psi (137.9 bar)
Lining Material	Non-asbestos	Non-asbestos	Non-asbestos
Lining Area per Brake	94.0 in ² (606.5 cm ²)	110.0 in ² (709.7 cm ²)	110.0 in ² (709.7 cm ²)
Lining Volume per Brake	85.0 in ³ (1,392.9 cm ³)	102.0 in ³ (1,671.5 cm ³)	102.0 in ³ (1,671.5 cm ³)
Disc Thickness	1.0 in (25.4 mm)	1.0 in (25.4 mm)	1.0 in (25.4 mm)
Disc Diameter Range	18.0 in to 20.0 in (457.2 mm to 508.0 mm)	18.0 in to 25.0 in (457.2 mm to 635.0 mm)	18.0 in to 25.0 in (457.2 mm to 635.0 mm)
Displacement per Brake	2.8 in ³ (45.9 cm ³)	2.8 in ³ (45.9 cm ³)	2.9 in ³ (47.5 cm ³)
Number of Pistons	4	4	4
Final Assembly Weight	120.0 lbs (54.4 kg)	122.0 lbs (55.3 kg)	122.0 lbs (55.3 kg)

Formulas

Torque (lb-in) = K x Pressure (psi) x Disc Friction Radius (in)
 Torque (N-m) = K x Pressure (bars) x Disc Friction Radius (mm)
 Friction Radius (in) = [Disc Diameter (in)]/2] - 2.18 in
 Friction Radius (mm) = [Disc Diameter (mm)]/2] - 55.4 mm

	English	Metric
K (Dynamic)	4.330	0.2793
K (Static)	6.494	0.4190

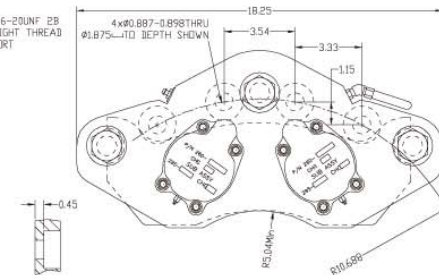
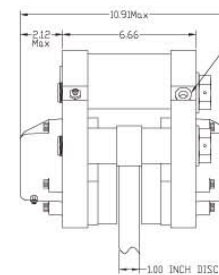

FF6 SERVICE BRAKE

Description

The Carlisle FF6 series brakes are hydraulically actuated, six pistons, disc brakes with springs and automatic adjusters. These brakes are typically bolted to the armature shaft of an electric wheel motor equipped with a 31" diameter disc.

FEATURES

- Piston housings constructed from ductile iron casting for superior brake durability
- Equipped with Carlisle premium asbestos-free linings, providing superior stopping performance and life
- Optional seal materials available for compatibility with all actuation fluids and temperatures
- Modular piston design for easy serviceability
- Piston insulators are standard to protect brake components from heat transfer

APPLICATION

- Electric drive surface mining haulage trucks
- Earthmoving equipment
- Mining equipment
- Industrial equipment

Specifications

Caliper Material	Steel and Ductile Iron
Mounting Attitude	Any Position
Maximum Pressure	2,000 psi (137.9 bar)
Lining Material	Non-asbestos
Lining Area per Brake	136.0 in ² (877.4 cm ²)
Lining Volume per Brake	126.0 in ³ (2064.8 cm ³)
Disc Thickness	1.25 in (31.8 mm)
Disc Diameter Range	28.0 in to 31.0 in (711.2 mm to 787.4 mm)
Displacement per Brake	4.8 in ³ (78.6 cm ³)
Number of Pistons	6
Final Assembly Weight	172.0 lbs (78.0 kg)

Formulas

Torque(lb-in) = K * Pressure (psi) * Disc Friction Radius (in)
 Torque(N-m) = K * Pressure (bars) * Disc Friction Radius (mm)
 Friction Radius (in) = [Disc Diameter (in) / 2] - 2.4 in
 Friction Radius (mm) = [Disc Diameter (mm) / 2] - 61.0 mm

	English	Metric
K (Dynamic)	6.494	0.4190
K (Static)	9.741	0.6285

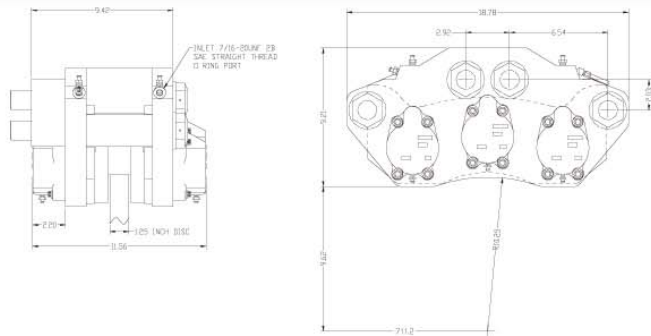

J6 SERVICE BRAKE

Description

The Carlisle J6 brake is a hydraulically actuated, six-piston, wheel-mounted, caliper disc brake designed for a variety of surface-mining haulage trucks. The J6 is typically bolted to a flange on the vehicle's axle or mounting bracket.

FEATURES

- Constructed from ductile iron castings for superior brake durability
- Equipped with Carlisle premium asbestos-free linings providing excellent stopping performance and long-life machines
- Variety of seal materials and designs available to accommodate all vehicle applications
- Optional segmented discs available for easy serviceability
- Open caliper provides quick access for visual inspection and serviceability
- Available with automatic adjuster and spring-activated piston retraction

APPLICATION

- Surface-mining haulage trucks
- Large mobile construction and mining equipment

Specifications

Caliper Material	High-strength ductile iron
Mounting Attitude	1:30 to 4:30, 7:30 to 10:30 o'clock
Maximum Pressure	3,000 psi (206.9 bar)
Lining Material	Non-asbestos
Lining Area per Brake	152.0 in ² (980.6 cm ²)
Lining Volume per Brake	137.0 in ³ (2,245.0 cm ³)
Disc Thickness	1.0 in (25.4 mm)
Disc Diameter Range	35.0 in to 46.0 in (889.0 mm to 1,168.4 mm)
Displacement per Brake	2.5 in ³ (41.0 cm ³)
Number of Pistons	6
Final Assembly Weight	265.0 lbs (120.2 kg)

Formulas

Torque (lb-in) = K x Pressure (psi) x Disc Friction Radius (in)
 Torque (N-m) = K x Pressure (bars) x Disc Friction Radius (mm)
 Friction Radius (in) = Disc Diameter (in) / 2 - 2.12 in
 Friction Radius (mm) = Disc Diameter (mm) / 2 - 53.8 mm

	English	Metric
K (Dynamic)	21.359	1.3780
K (Static)	17.318	1.1173

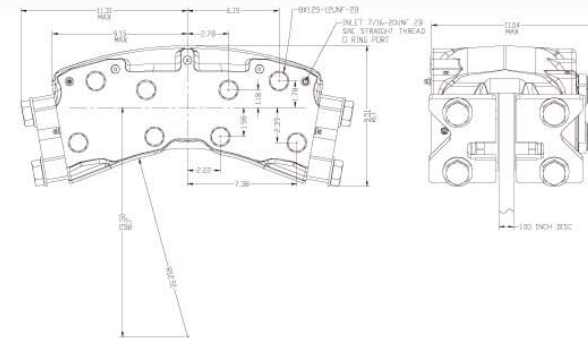

M6-25 SERVICE BRAKE

Description

The Carlisle M6-25 brake is a hydraulically actuated, six-piston, caliper disc brake designed for a variety of dynamic braking requirements. This brake is typically mounted to a flange on the vehicle's axle or mounting bracket for service brake applications.

FEATURES

- Flexible mounting alternatives to accommodate numerous vehicle types
- Constructed from ductile iron casting for superior brake durability
- Equipped with Carlisle premium asbestos-free linings, providing superior stopping performance and life
- Optional seal materials available for compatibility with all actuation fluids and temperatures
- Open caliper provides easy access for visual inspection and serviceability

APPLICATION

- Mobile construction and mining equipment
- Agricultural machines
- Logging industry vehicles
- Industrial equipment

Specifications

Caliper Material	High-strength ductile iron
Mounting Attitude	3, 9 o'clock
Maximum Pressure	2,300 psi (158.6 bar)
Lining Material	Non-asbestos
Lining Area per Brake	85 in ² (548.4 cm ²)
Lining Volume per Brake	60 in ³ (983.2 cm ³)
Disc Thickness	0.75 in (19.1 mm)
Disc Diameter Range	18.0 in to 20.0 in (457.2 mm to 508.0 mm)
Displacement per Brake	1.3 in ³ (21.3 cm ³)
Number of Pistons	6
Final Assembly Weight	132.5 lbs (60.1 kg)

Formulas

Torque (lb-in) = K x Pressure (psi) x Disc Friction Radius (in)
 Torque (N-m) = K x Pressure (bars) x Disc Friction Radius (mm)
 Friction Radius (in) = Disc Diameter (in)/2 - 1.7 in
 Friction Radius (mm) = Disc Diameter (mm)/2 - 43.2 mm

	English	Metric
K (Dynamic)	17.027	1.0985
K (Static)	13.806	0.8907

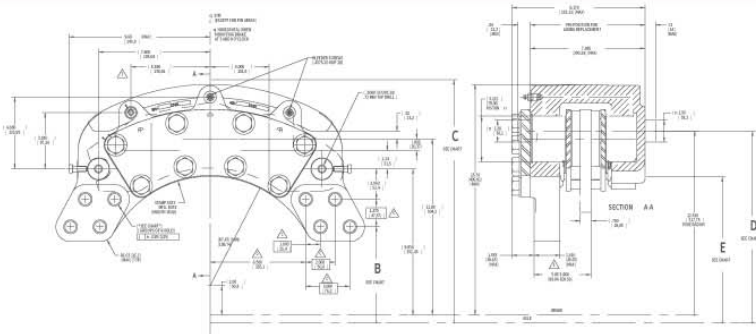

M6-29 SERVICE BRAKE

Description

The Carlisle M6-29 brake is a hydraulically actuated, six-piston, caliper disc brake designed for a variety of dynamic braking requirements. This brake is typically mounted to a flange on the vehicle's axle or mounting bracket for service brake applications.

FEATURES

- Flexible mounting alternatives to accommodate numerous vehicle types
- Constructed from ductile iron casting for superior brake durability
- Equipped with Carlisle premium asbestos-free linings, providing superior stopping performance and life
- Optional seal materials available for compatibility with all actuation fluids and temperatures
- Open caliper provides easy access for visual inspection and serviceability

APPLICATION

- Mobile construction and mining equipment
- Agricultural machines
- Logging industry vehicles
- Industrial equipment

Specifications

Caliper Material	High-strength ductile iron
Mounting Attitude	3, 9 o'clock
Maximum Pressure	2,300 psi (158.6 bar)
Lining Material	Non-asbestos
Lining Area per Brake	108.0 in ² (696.8 cm ²)
Lining Volume per Brake	75.0 in ³ (1,229.0 cm ³)
Disc Thickness	0.75 in (19.1 mm)
Disc Diameter Range	26.0 in to 30.0 in (660.4 mm to 762.0 mm)
Displacement per Brake	1.5 in ³ (24.6 cm ³)
Number of Pistons	6
Final Assembly Weight	156.2 lbs (70.9 kg)

Formulas

Torque (lb-in) = K x Pressure (psi) x Disc Friction Radius (in)
 Torque (N-m) = K x Pressure (bars) x Disc Friction Radius (mm)
 Friction Radius (in) = Disc Diameter (in)/2 - 2.0 in
 Friction Radius (mm) = Disc Diameter (mm)/2 - 50.8 mm

	English	Metric
K (Dynamic)	17.027	1.0985
K (Static)	13.806	0.8907

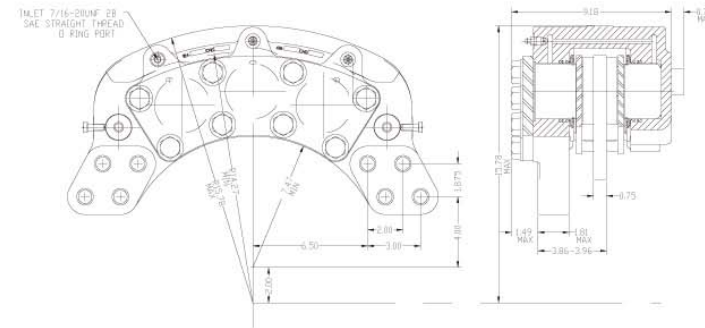

M4 SERVICE BRAKE

Description

The Carlisle M4 brake is a hydraulically actuated, four-piston, caliper disc brake designed for a variety of dynamic braking requirements. This brake is typically mounted to a flange on the vehicle's axle or mounting bracket for service brake applications.

FEATURES

- Flexible mounting alternatives to accommodate numerous vehicle types
- Constructed from ductile iron casting for superior brake durability
- Equipped with Carlisle premium asbestos-free linings, providing superior stopping performance and life
- Optional seal materials available for compatibility with all actuation fluids and temperatures
- Open caliper provides easy access for visual inspection and serviceability

APPLICATION

- Mobile construction and mining equipment
- Agricultural machines
- Logging industry vehicles
- Industrial equipment

Specifications

Caliper Material	High-strength ductile iron
Mounting Attitude	3, 9 o'clock
Maximum Pressure	2,300 psi (158.6 bar)
Lining Material	Non-asbestos
Lining Area per Brake	68.0 in ² (439.0 cm ²)
Lining Volume per Brake	48.0 in ³ (787.0 cm ³)
Disc Thickness	0.625 in to 0.750 in (15.9 mm to 19.1 mm)
Disc Diameter Range	18.0 in to 20.0 in (457.2 mm to 508.0 mm)
Displacement per Brake	1.0 in ³ (16.4 cm ³)
Number of Pistons	4
Final Assembly Weight	98.0 lbs (44.5 kg)

Formulas

Torque (lb-in) = $K \times \text{Pressure (psi)} \times \text{Disc Friction Radius (in)}$
 Torque (N-m) = $K \times \text{Pressure (bars)} \times \text{Disc Friction Radius (mm)}$
 Friction Radius (in) = $\text{Disc Diameter (in)} / 2 - 1.7 \text{ in}$
 Friction Radius (mm) = $\text{Disc Diameter (mm)} / 2 - 43.2 \text{ mm}$

	English	Metric
K (Dynamic)	11.351	0.7324
K (Static)	9.204	0.5938

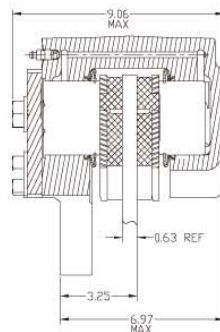
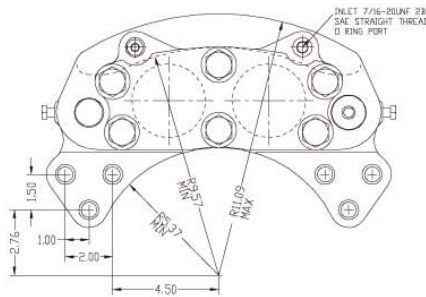

PD1425 SERVICE BRAKE

Description

The Carlisle PD1425 series brake is a hydraulically actuated, double opposed piston, caliper disc brake with retracting springs and automatic adjusters. Both the caliper and disc require fixed mountings. This brake provides high torque ranges for severe service conditions. Multiple calipers may be used on a single disc to proportionately increase torque output.

FEATURES

- Flexible mounting alternatives to accommodate numerous vehicle types
- Constructed from ductile iron casting for superior brake durability
- Equipped with Carlisle premium asbestos-free linings, providing superior stopping performance and life
- Optional seal materials available for compatibility with all actuation fluids and temperatures

APPLICATION

- Surface mining haulage trucks
- Fork lift trucks
- Mobile construction and mining equipment

Specifications

Caliper Material	High-strength ductile iron
Mounting Attitude	6, 12 o'clock
Maximum Pressure	2,000 psi (137.9 bar)
Minimum Pressure	100 psi (6.89 bar)
Inlet Type	.4375-20 UNF
Lining Material	Non-asbestos, organic
Lining Area per Brake	102 in ² (658 cm ²)
Lining Volume per Brake	104 in ³ (1,700 cm ³)
Disc Thickness	1 in (25.4 mm)
Disc Diameter Range	19 in (482.6 mm) to 25 in (635 mm)
Displacement per Brake	2.25 in ³ (36.9 cm ³)
Number of Pistons	4
Final Assembly Weight	137 lbs (62 kg)

Formulas

English

Torque (lb-ft-in)
 = $K \times (\text{Input Pressure} - 100) (\text{psi}) \times \text{Disc Friction Radius (in)}$

Disc Friction Radius (in) = $\text{Disc Diameter (in)} \div 2 - 2.0 \text{ (in)}$

K (Dynamic) = 6.49

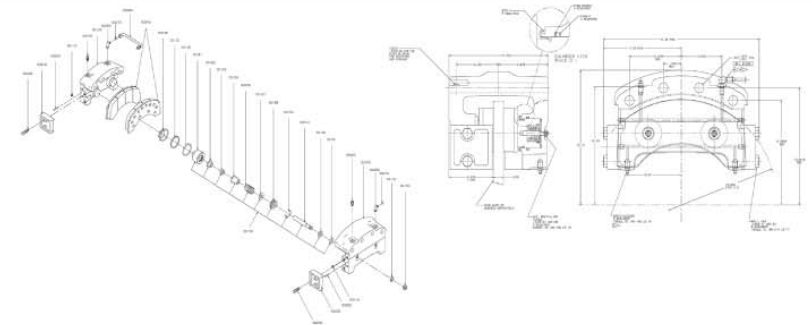

SCL2 SERVICE BRAKE

Description

The Carlisle SCL2 series brake is a hydraulically actuated, double opposed piston, caliper disc brake designed for heavy-duty, high torque applications. Both the caliper and disc require fixed mountings. Multiple calipers may be used on a single disc to proportionately increase torque output. This brake is also available with retracting springs and automatic adjusters, ideal for high speed applications.

FEATURES

- Flexible mounting alternatives to accommodate numerous vehicle and equipment types
- Constructed from ductile iron casting for superior brake durability
- Equipped with Carlisle premium asbestos-free linings, providing superior stopping performance and life
- Optional seal materials available for compatibility with all actuation fluids and temperatures
- Many variations available

APPLICATION

- Wheel loaders
- Articulated haulers
- Front-end loaders
- Compactors
- Rough terrain cranes
- Tow tractors

Specifications

	Standard Model	Auto-Adjust Model
Caliper Material	High-strength ductile iron	High-strength ductile iron
Mounting Attitude	3, 9, 12 o'clock	3, 9, 12 o'clock
Maximum Pressure	1,900 psi (131 bar) or 2,300 psi (158.6 bar)	1,900 psi (131 bar)
Minimum Pressure	0 psi (0 bar)	75 psi (5.17 bar)
Inlet Type	.500-20 UNF or .125-27 NPTF	.4375-20 UNF
Lining Material	Non-asbestos, organic	Non-asbestos, organic
Lining Area per Brake	64 in ² (413 cm ²)	64 in ² (413 cm ²)
Lining Volume per Brake	42 in ³ (988 cm ³) or 38 in ³ (623 cm ³)	42 in ³ (688 cm ³)
Disc Thickness	.625 in (15.9 mm)	.625 in (15.9 mm)
Disc Diameter Range	16 in (406 mm) to 25 in (635 mm)	unlimited
Displacement per Brake	1.34 in ³ (22 cm ³)	2.3 in ³ (37.7 cm ³)
Number of Pistons	4	4
Final Assembly Weight	88 lbs (40 kg)	88 lbs (40 kg)

Formulas

English

Standard Model

Torque (lbf-in)

$$= K \times \text{Input Pressure (psi)} \times \text{Disc Friction Radius (in)}$$

$$\text{Disc Friction Radius (in)} = \text{Disc Diameter (in)} \div 2 - 1.5 \text{ (in)}$$

$$K \text{ (Dynamic)} = 10.18$$

Auto-Adjust Model

Torque (lbf-in)

$$= K \times (\text{Input Pressure} - 75) \text{ (psi)} \times \text{Disc Friction Radius (in)}$$

$$\text{Disc Friction Radius (in)} = \text{Disc Diameter (in)} \div 2 - 1.5 \text{ (in)}$$

$$K \text{ (Dynamic)} = 8.4$$

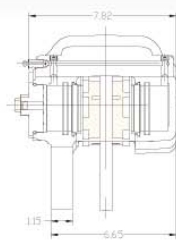
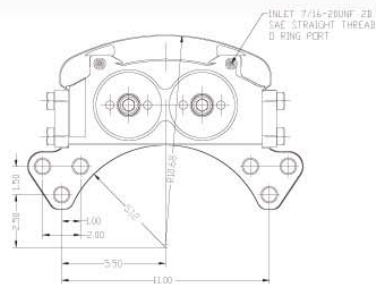

SCL56 SERVICE BRAKE

Description

The Carlisle SCL56 series brake is a hydraulically actuated, triple opposed piston, caliper disc brake designed for heavy-duty, high torque, high energy dynamic braking. Both the caliper and disc require fixed mountings. Multiple calipers may be used on a single disc to proportionately increase torque output. Most commonly used at the wheel location with 49 inch and 51 inch rims.

FEATURES

- Flexible mounting alternatives to accommodate numerous vehicle types
- Constructed from ductile iron casting for superior brake durability
- Equipped with Carlisle premium asbestos-free linings, providing superior stopping performance and life
- Optional seal materials available for compatibility with all actuation fluids and temperatures

APPLICATION

- Surface mining haulage trucks
- Straddle carriers
- Front-end loaders

Specifications

Caliper Material	High-strength ductile iron
Mounting Attitude	3, 9, 12 o'clock
Maximum Pressure	2,600 psi (179 bar) or 3,000 psi (207 bar)
Inlet Type	.562-18 UNF
Lining Material	Non-asbestos, organic
Lining Area per Brake	102 in ² (658 cm ²)
Lining Volume per Brake	104 in ³ (1,704 cm ³)
Disc Thickness	1.25 in (31.75 mm)
Disc Diameter	19 in (483 mm) and 52 in (1,320 mm)
Displacement per Brake	3.0 in ³ (49 cm ³)
Number of Pistons	6
Final Assembly Weight	214 lbs (97 kg)

Formulas

English Units*

Torque (lbf-in)

$$= K \times \text{Input Pressure (psi)} \times \text{Disc Friction Radius (in)}$$

$$\text{Disc Friction Radius (in)} = \text{Disc Diameter (in)} \div 2 - 2.0 \text{ (in)}$$

$$K \text{ (Dynamic)} = 20.72$$

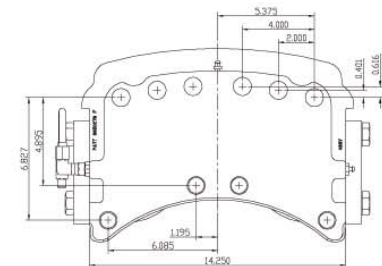
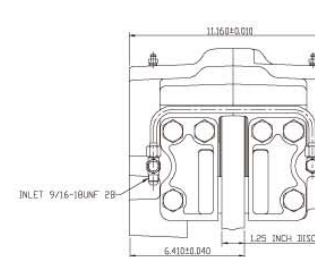

MMK2 SERIES

Description

The MMK2 spring applied, hydraulically released 2 piston caliper can be installed in small machines. Weighing only 8.84 kgs, it can operate with mineral oil or brake fluid.

FEATURES

- Flexible mounting alternative to accommodate numerous machine and equipment types.
- Constructed from ductile iron casting for superior brake durability
- Equipped with Carlisle premium linings, providing superior stopping performance and life.
- Optional seal materials available for compatibility with all actuation fluids and temperature.
- Optional available on auto-adjuster model.

APPLICATION

- Industrial machine
- Agriculture machine
- Forestry machine

Specifications

Caliper Material	High-strength ductile iron
Mounting Attitude	3, 9, and 12 o'clock
Maximum Pressure	1,496 psi (103 bar)
Inlet Type	R1/4-19 (Taper thread)
Lining Material	Non-asbestos, organic
Lining Area per Brake	112.0 cm ²
Lining Volume per Brake	134.0 cm ³
Disk Thickness	unlimited
Disk Diameter Range	unlimited
Displacement per Brake	6.6 cm ³
Number of Pistons	2
Final Assembly Weight	8.84 kg

Formulas

Torque (N-m)
= K X Input pressure (MPa) X Disk Friction Radius (mm)

Disk Friction Radius(mm)
= Disk Diameter (mm) ÷ 2 - 24.0 (mm)

Metric

K (Dynamic)	2.536
K (Static)	2.054

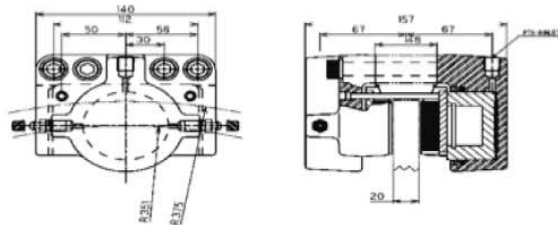

Brake Application Questionnaire



SALES REP :

DATE :

CUSTOMER INFORMATION

Company Name:	Telephone:
Contact:	E-Mail:
Address:	Fax:

APPLICATION INFORMATION

Vehicle Type:	Type of Brake (Dry Caliper, Drum, Wet):
Vehicle Model Number:	Actuation (Mechanical, Hydraulic, SAHR):
Approximate Annual Volume:	Actuation Fluid (Automotive Brake Fluid, Mineral Oil, Air):
Normal Brake Usage (Service, Park/Secondary):	Braking Standard to be Used:
Brake Location (Wheel, Drive Shaft):	

1 VEHICLE SPECIFICATIONS

Empty Vehicle Weight:	W empty	kg/lb				
Gross Vehicle Weight:	W gross	kg/lb				
Gear Reduction:	G eartotal	: 1	All gear reduction between the brake location and the vehicle ground contact.			
Gear Front wheel =		Gear Rear wheel =				
Total Resistance:	R %	%	2% standard unless otherwise specified			
Maximum Brake Pressure:		bar/psi				
Number of Braked Wheels:	n wheel					
Tire Rolling Radius / Static:	R static	m/in	Hub O.D.			
Brake Clearance / Rim I.D.:		m/in	Thickness	Front	m/in	Rear
Disc Dimensions / O.D.:	Front	m/in	Disc I.D.	Front	m/in	
	Rear	m/in		Rear	m/in	
Empty Weight Total:	T		of which front axle			
			of which middle axle			
			of which rear axle			
Loaded Weight Total:	T		of which front axle			
			of which middle axle			
			of which rear axle			

2 OPERATING SPECIFICATIONS

Grade Hold Requirement:	G static%	%		
Maximum Level Surface Speed:	V max	kph/mph		
Stop Distance Requirement:	S stop	m/ft		
System Actuating Time Delay:	t delay	sec	3 sec will be used unless otherwise specified.	
Dynamic Grade Requirement:	G dyn%	%	0% will be used unless otherwise specified.	
Ground Coefficient:	μ ground		5 is typical ground coefficient for unmaintained loose earth.	

COMMENTS

FAX: 0086 512 6805 0029 Email: CBF_AP_Marketing@carlislecbf.com

Brake Application Questionnaire



SALES REP :

DATE :

CUSTOMER INFORMATION

Company Name:	Telephone:
Contact:	E-Mail:
Address:	Fax:

APPLICATION INFORMATION

Vehicle Type:	Type of Brake (Dry Caliper, Drum, Wet):
Vehicle Model Number:	Actuation (Mechanical, Hydraulic, SAHR):
Approximate Annual Volume:	Actuation Fluid (Automotive Brake Fluid, Mineral Oil, Air):
Normal Brake Usage (Service, Park/Secondary):	Braking Standard to be Used:
Brake Location (Wheel, Drive Shaft):	

1 VEHICLE SPECIFICATIONS

Empty Vehicle Weight:	W _{empty}	kg/lb			
Gross Vehicle Weight:	W _{gross}	kg/lb			
Gear Reduction:	G _{overall}	: 1	All gear reduction between the brake location and the vehicle ground contact.		
Gear Front wheel =		Gear Rear wheel =			
Total Resistance:	R %	%	2% standard unless otherwise specified		
Maximum Brake Pressure:		bar/psi			
Number of Braked Wheels:	n _{wheel}				
Tire Rolling Radius / Static:	R _{static}	m/in	Hub O.D.		m/in
Brake Clearance / Rim I.D.:		m/in	Thickness	Front	m/in
Disc Dimensions / O.D.:	Front	m/in	Disc I.D.	Front	m/in
	Rear	m/in	Rear		m/in
Empty Weight Total:	T	of which front axle			
		of which middle axle			
		of which rear axle			
Loaded Weight Total:	T	of which front axle			
		of which middle axle			
		of which rear axle			

2 OPERATING SPECIFICATIONS

Grade Hold Requirement:	G _{static} %	%		
Maximum Level Surface Speed:	V _{max}	kph/mph		
Stop Distance Requirement:	S _{stop}	m/ft	V _{max}	kph/mph
System Actuating Time Delay:	t _{delay}	sec	S _{stop}	m/ft
Dynamic Grade Requirement:	G _{dyn} %	%	3 sec will be used unless otherwise specified.	
Ground Coefficient:	μ _{ground}		0% will be used unless otherwise specified.	
			5 is typical ground coefficient for unmaintained loose earth.	

COMMENTS

PARK BRAKES

- | | | | |
|----|-------------------------------------|----|------------------------------------|
| 23 | G1 SERIES BRAKES | 27 | SA-7000 SERIES LOW PRESSURE BRAKES |
| 24 | G2 SERIES BRAKES | 28 | SA-10000 SERIES BRAKES |
| 25 | RT SERIES BRAKES | 29 | SA-14000 SERIES BRAKES |
| 26 | SA-7000 SERIES HIGH PRESSURE BRAKES | 30 | SCL70 SERIES BRAKES QUESTIONNAIRE |

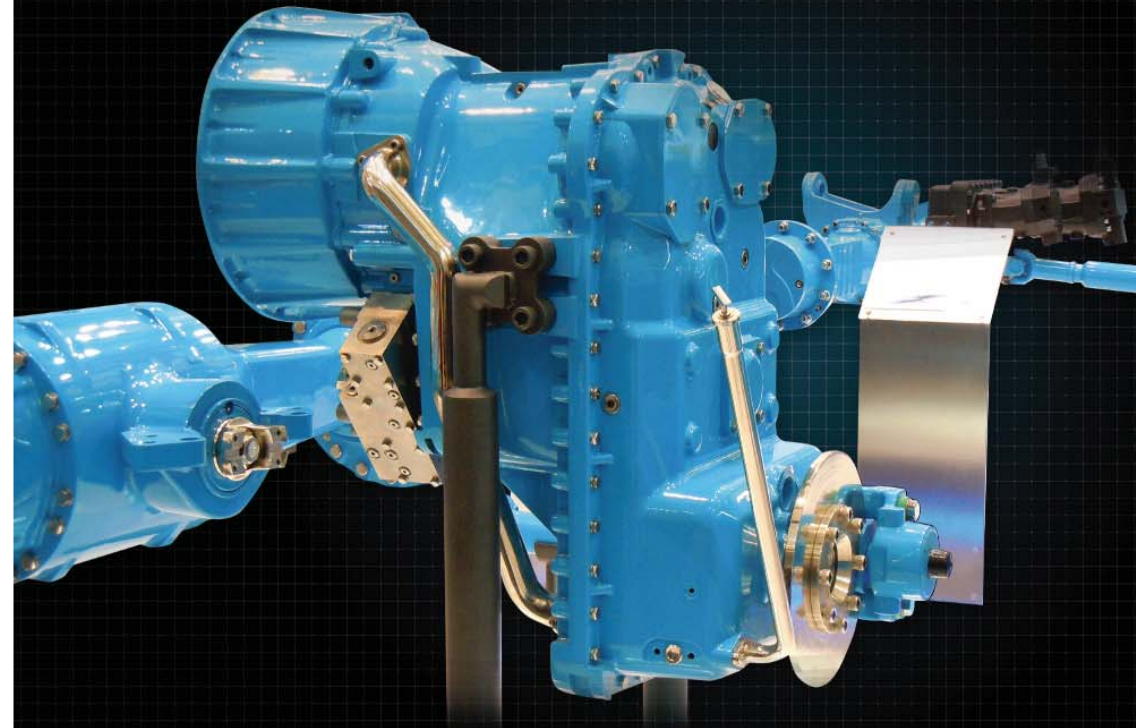

G1 SERIES BRAKES

Description

The Carlisle G1 brake is spring applied and released by air or hydraulic pressure. The brake is supplied without torque bars or a torque plate with the customer making provisions for mounting hardware. (Please contact Carlisle regarding dynamic braking applications.) Available with both manual and automatic slack adjusters / air or hydraulic release.

FEATURES

- Ideal for industrial braking needs
- Constructed from ductile iron for superior brake durability
- Equipped with Carlisle premium asbestos-free lining
- Less fade in emergency situations than brake drums
- Open caliper provides easy access for visual inspection and serviceability

APPLICATION

- Front-end loaders, haulers and other construction vehicles
- Mining vehicles
- Industrial applications
- Park brake where dynamic requirements exist

Specifications

* Thinner discs can be used. Contact Carlisle for information.

Caliper Material	High-strength ductile iron
Mounting Attitude	Any position desired
Maximum Lever Force	2,000 lbs (8,896 N)
Lining Material	Non-asbestos
Lining Area per Brake	44.0 in ² (283.9 cm ²)
Lining Volume per Brake	41.0 in ³ (671.9 cm ³)
Disc Thickness	1.125 in (28.6 mm)*
Disc Diameter Range	15.13 in to 20.42 in (384.3 mm to 518.7 mm)
Displacement per Brake	4.0 in ³ (65.5 cm ³)
Number of Pistons	1
Final Assembly Weight	75.0 lbs (34.0 kg)

Formulas

Torque (lb-in) = K x Lever Force (lbs) x Disc Friction Radius (in)
 Torque (N-m) = K x Lever Force (N) x Disc Friction Radius (mm)
 Friction Radius (in) = Disc Diameter (in) / 2 - 1.2 in
 Friction Radius (mm) = Disc Diameter (mm) / 2 - 30.5 mm

Slack Adjuster Type	Lever Length		K (Static)	
	English	Metric	English	Metric
Automatic or Manual	5.0 in	127.0 mm	5.0	127.0
Manual	6.0 in	152.4 mm	6.0	152.4
Automatic	6.1 in	154.9 mm	6.1	154.9

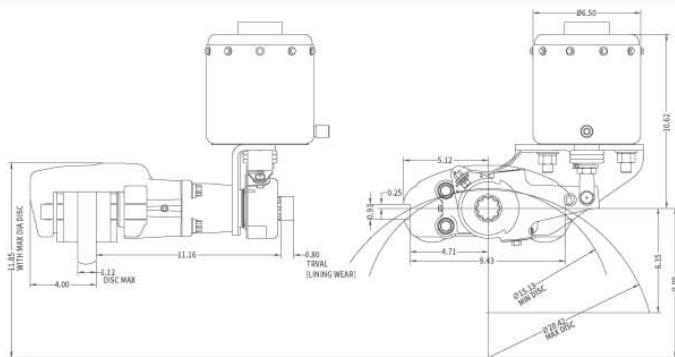

G2 SERIES BRAKES

Description

The Carlisle G2 brakes are spring applied, hydraulically released park brakes. They have manual adjustment to compensate for lining wear. Their variations include seals for mineral oil or automotive brake fluid and five, six, or seven springs. These brakes are NOT used in dynamic applications.

FEATURES

- Spring Applied, hydraulic release
- Metallic non-asbestos linings

APPLICATION

- Mining Trucks
- Industrial equipment

Specifications

Caliper Material	Steel and ductile iron
Mounting Attitude	3, 6, 12 o'clock
Maximum Pressure	3,000 psi (206.9 bar)
Minimum Pressure to Fully Retract	
G2-5 (5 springs)	1,300 psi (89.7 bar)
G2-6 (6 springs)	1,600 psi (110.3 bar)
G2-7 (7 springs)	1,800 psi (124.1 bar)
Lining Material	Metallic Non-asbestos
Lining Area per Brake	8.2 in ² (52.9 cm ²)
Lining Volume per Brake	1.5 in ³ (24.6 cm ³)
Disc Thickness	0.5 in - 1.0 in (12.7 mm - 25.4 mm)
Disc Diameter Range	18.0 in to 45.0 in (457.2 mm to 1,143.0 mm)
Displacement per Brake	3.0 in ³ (49.2 cm ³)
Number of Pistons	2
Final Assembly Weight	120.0 lbs (54.4 kg)

Formulas

Torque (lb-in) = K x Disc Friction Radius (in)
 Torque (N-m) = K x Disc Friction Radius (mm)
 Friction Radius (in) = Disc Diameter (in) / 2 - 2.0 in
 Friction Radius (mm) = Disc Diameter (mm) / 2 - 50.8 mm

K (STATIC)

Brake	New		Worn	
	English	Metric	English	Metric
G2-5	9,150	40,70	5,270	23,44
G2-6	10,980	48,84	6,324	28,13
G2-7	12,810	56,98	7,378	32,82

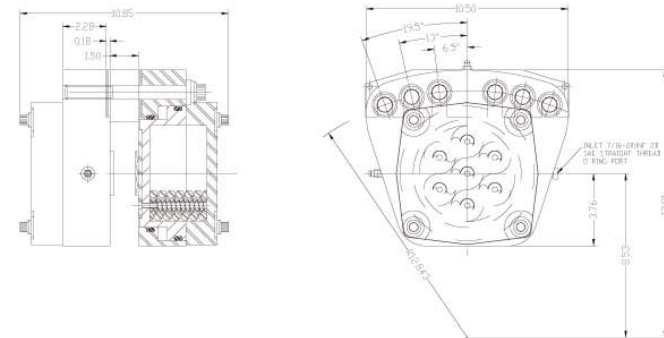

RT SERIES BRAKES

Description

This mechanically actuated, sliding caliper brake is designed for static/secondary applications. (Please contact Carlisle regarding dynamic braking applications.)

FEATURES

- Ideal for parking, secondary and industrial braking needs
- Ductile iron casting for high strength
- Quick-change non-asbestos organic or sintered metallic linings
- Less fade in emergency situations than brake drums
- Open caliper provides easy access for visual inspection, serviceability and lower maintenance costs
- Lining retraction springs reduce parasitic drag
- Actuation lever may be indexed at 60° intervals
- Brake can be supplied with mounting hardware

APPLICATION

- Front-end loaders, backhoe loaders and other construction vehicles
- Underground mining vehicles
- Agricultural machines
- On-highway vehicles
- Industrial Equipment

Specifications

Caliper Material	High-strength ductile iron
Actuation	Cam and ball
Mounting	Sliding pin
Input Force	425 lbs (1,890 N)
Torque on 10.0 in (254.0 mm) Dia. Disc	18, 785 lb-in (2, 122 N-m)
Lining Material	Non-asbestos or sintered metallic
Lining Area per Brake	9.55 in ² (61.6 cm ²)
Lining Volume per Brake	2.39 in ³ (39.2 cm ³)
Disc Thickness Range	0.31 in to 0.5 in (7.9 mm to 12.7 mm)
Disc Diameter Range	8.0 in to 20.0 in (203.2 mm to 508.0 mm)
Final Assembly Weight	Estimated 7.0 lbs (3.2 kg)
Lever Travel	45°

Formulas

Torque (lb-in) = K x Lever Force (lbs) x Disc Friction Radius (in)
 Torque (N-m) = K x Lever Force (N) x Disc Friction Radius (mm)
 Friction Radius (in) = Disc Diameter (in) / 2 - 0.75 in
 Friction Radius (mm) = Disc Diameter (mm) / 2 - 19.05 mm

	English	Metric
K (Static)	10.4000	0.0104

SA-7000 SERIES HIGH PRESSURE BRAKES

Description

This spring-applied, hydraulically released, sliding caliper brake is designed for static/secondary applications. (Please contact Carlisle regarding dynamic braking applications.)

FEATURES

- Return spring device for centering caliper on disc
- Simple adjustment - remove end cap and turn two adjustment bolts
- Ideal for parking, secondary and industrial braking needs
- Ductile iron casting for high strength
- Quick-change, non-asbestos organic or sintered metallic linings
- Less fade in emergency situations than brake drums
- Open caliper provides easy access for visual inspection, serviceability and low maintenance costs
- Brake supplied with mounting hardware
- Cantilever mount with special jam nuts

APPLICATION

- Front-end loaders, backhoe loaders and other construction vehicles
- Agricultural machines
- On-highway vehicles
- Industrial Equipment

Formulas

Torque = TBF x Disc Friction Radius
 Friction Radius (in) = Disc Diameter (in) / 2 - 1.00 in
 Friction Radius (mm) = Disc Diameter (mm) / 2 - 25.40 mm
 The above formulas are for static applications only.

TBF	English (lbs)	Metric (N)	Disc Diameter	Mounting Location
Static (new)	5,300	23,575	10.00	5.250
Static (worn)	4,000	17,792	11.00	5.750
*Dynamic (new)	2,650	11,787	12.00	6.250
*Dynamic (worn)	2,000	8,896	13.00	6.750
			13.40	6.950
			14.00	7.250
			15.00	7.750
			16.00	8.250
			17.00	8.750
			18.00	9.250
			19.00	9.750
			20.00	10.250

* Dynamic TBF values shown are approximations. Consult Carlisle Engineering with specific application information for dynamic consideration.
 New = .020" running clearance;
 Worn = .100" running clearance

Specifications

Caliper Material	High-strength ductile iron
Actuation	Spring applied, hydraulically released
Mounting	Cantilever mounting on sliding pin; 3/4 - 10 thread
Release Pressure	1,150 psi - 3,000 psi (79.29 bar - 206.84 bar)
Lining Material	Non-asbestos organic or sintered metallic
Lining Area per Brake	15.84 in ² (102.2 cm ²)
Lining Volume per Brake	3.96 in ³ (64.95 cm ³)
Disc Thickness Range	0.38 in to 0.50 in (9.5 mm to 12.7 mm)
Disc Diameter Range	10.0 in to 20.0 in (254.0 mm to 508.0 mm)
Final Assembly Weight	Estimated 28.8 lbs (13.06 kg)

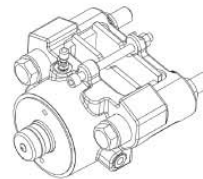

DISC DIA.	MOUNTING LOCATION
10.00	5.250
11.00	5.750
12.00	6.250
13.00	6.750
14.00	7.250
15.00	7.750
16.00	8.250
17.00	8.750
18.00	9.250
19.00	9.750
20.00	10.250

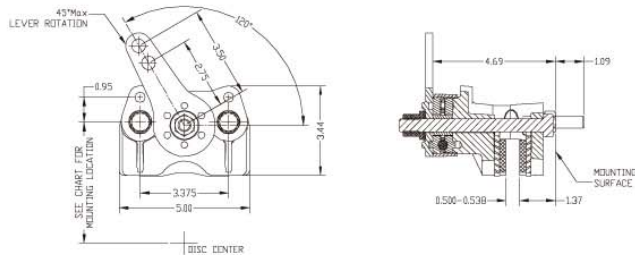
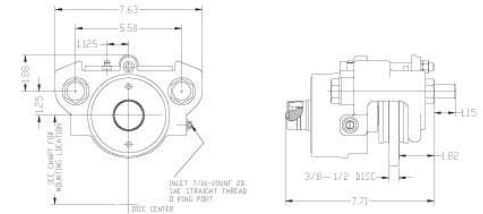

DISC DIA.	MOUNTING LOCATION
8.00	4.500
9.00	5.000
10.00	5.500
11.00	6.000
12.00	6.550
13.00	7.075
14.00	7.575
15.00	8.100
16.00	8.600
17.00	9.125
18.00	9.625
19.00	10.150
20.00	10.650

SA-7000 SERIES LOW PRESSURE BRAKES

Description

This spring-applied, hydraulically released, sliding caliper brake is designed for static/secondary applications. (Please contact Carlisle regarding dynamic braking applications.)

FEATURES

- Return spring device for centering caliper on disc
- Simple adjustment - remove end cap and turn two adjustment bolts
- Ideal for parking, secondary and industrial braking needs
- Ductile iron casting for high strength
- Quick-change non-asbestos organic or sintered metallic linings
- Less fade in emergency situations than brake drums
- Open caliper provides easy access for visual inspection, serviceability and lower maintenance costs
- Brake supplied with mounting hardware
- Cantilever mount with special jam nuts

Specifications

Caliper Material	High-strength ductile iron
Actuation	Spring applied, hydraulically released
Mounting	Cantilever mounting on sliding pin; 3/4 -10 thread
Release Pressure	170 psi - 270 psi (11.7 bar - 18.6 bar)
Lining Material	Non-asbestos or sintered metallic
Lining Area per Brake	15.84 in ² (102.2 cm ²)
Lining Volume per Brake	3.96 in ³ (64.95 cm ³)
Disc Thickness Range	0.38 in to 0.50 in (9.5 mm to 12.7 mm)
Disc Diameter Range	10.0 in to 20.0 in (254.0 mm to 508.0 mm)
Final Assembly Weight	Estimated 36.0 lbs (16.33 kg)

APPLICATION

- Front-end loaders, backhoe loaders and other construction vehicles
- Underground mining vehicles
- Agricultural machines
- On-highway vehicles
- Industrial Equipment

Formulas

Torque = TBF x Disc Friction Radius
 Friction Radius (in) = Disc Diameter (in) / 2 - 1.00 in
 Friction Radius (mm) = Disc Diameter (mm) / 2 - 25.40 mm
 The above formulas are for static applications only.

TBF	English (lbs)	Metric (N)
Static (new)	5,300	23,575
Static (worn)	4,000	17,792
*Dynamic (new)	2,650	11,787
*Dynamic (worn)	2,000	8,896

*Dynamic TBF values shown are approximations. Consult Carlisle Engineering with specific application information for dynamic consideration.
 New = .020" running clearance; Worn = .100" running clearance

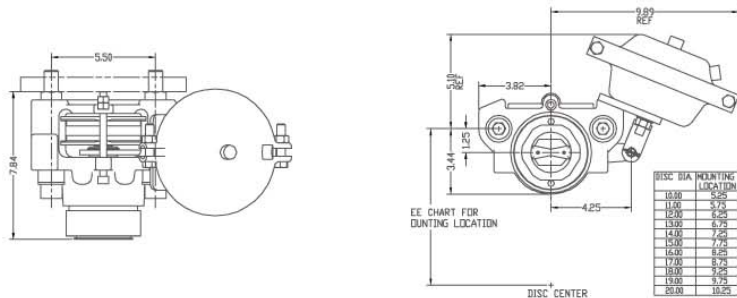

SA-10000 SERIES BRAKES

Description

The Carlisle SA-10000 series brake is a spring applied, hydraulically released (SAHR), two piston caliper disc brake designed for a variety of static/emergency applications. This brake incorporates a floating caliper design and requires a fixed disc mounting. A manual adjustment mechanism allows for lining wear. (Please contact Carlisle regarding any dynamic braking applications.)

FEATURES

- Constructed from ductile iron casting for superior brake durability
- Equipped with Carlisle premium asbestos-free linings, providing long life and superior stopping performance
- Spring centering device prevents lining drag
- Simple brake adjustment
- Open caliper provides easy access for visual inspection, serviceability, and lower maintenance costs
- Less fade than drum brakes in an emergency

APPLICATION

- Articulated dump trucks
- Agricultural machines
- Underground mining vehicles
- Construction equipment
- On-highway vehicles

Specifications

Caliper Material	High-strength ductile iron
Mounting	Double shear on slide pins
Minimum Release Pressure	1,100 psi (75.8 bar)
Maximum Pressure	3,000 psi (206.8 bar)
Inlet Type	.4375-20 UNF
Lining Material	Non-asbestos/semi-metallic
Lining Area per Brake	44.3 in ² (285.8 cm ²)
Lining Volume per Brake	22.2 in ³ (363 cm ³)
Disc Thickness	0.5 in or 1.0 in (25.4 mm)
Disc Diameter Range	14.25 in - 25 in (362 mm - 635 mm)
Final Assembly Weight	70 lbs (31.7 kg)

Formulas

Torque (lb-in) = K x Disc Friction Radius (in)
 Disc Friction Radius (in) = Disc Diameter (in) ÷ 2 - 1.22 in
 Torque (N-m) = K x Disc Friction Radius (m)
 Disc Friction Radius (mm) = Disc Diameter (mm) ÷ 2 - 31 mm

	English (lbs)	Metric (N)
K (Static - New)	14,371	63,701
K (Static - Worn)	9,023	40,135

* Total braking forces shown are after lining burnish.

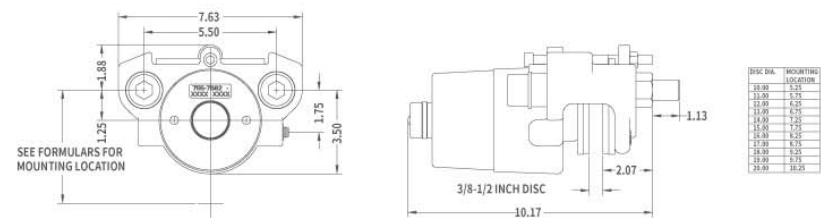

SA-14000 SERIES BRAKES

Description

The Carlisle SA-14000 series brake is a spring applied, hydraulically released (SAHR), two piston caliper disc brake designed for a variety of static/emergency applications. This brake incorporates a floating caliper design and requires a fixed disc mounting. A manual adjustment mechanism allows for lining wear. (Please contact Carlisle regarding any dynamic braking applications.)

FEATURES

- Constructed from ductile iron casting for superior brake durability
- Equipped with Carlisle premium asbestos-free linings, providing long life and superior stopping performance
- Spring centering device prevents lining drag
- Simple brake adjustment
- Open caliper provides easy access for visual inspection, serviceability, and lower maintenance costs
- Less fade than drum brakes in an emergency

APPLICATION

- Articulated dump trucks
- Agricultural machines
- Underground mining vehicles
- Construction equipment
- On-highway vehicles

Specifications

Caliper Material	High-strength ductile iron
Mounting	Double shear on slide pins
Minimum Release Pressure	1,100 psi (75.8 bar)
Maximum Pressure	3,000 psi (206.8 bar)
Inlet Type	.4375-20 UNF
Lining Material	Non-asbestos/semi-metallic
Lining Area per Brake	44.3 in ² (285.8 cm ²)
Lining Volume per Brake	22.2 in ³ (363 cm ³)
Disc Thickness	0.5 in or 1.0 in (25.4 mm)
Disc Diameter Range	14.25 in - 25 in (362 mm - 635 mm)
Final Assembly Weight	70 lbs (31.7 kg)

Formulas

Torque (lbf-in) = K × Disc Friction Radius (in)
 Disc Friction Radius (in) = Disc Diameter (in) ÷ 2 - 1.122 in
 Torque (N-m) = K × Disc Friction Radius (m)
 Disc Friction Radius (mm) = Disc Diameter (mm) ÷ 2 - 31 mm

	English (lbs)	Metric (N)
K (Static - New)	14,371	63,701
K (Static - Worn)	9,023	40,135

* Total braking forces shown are after lining burnish.

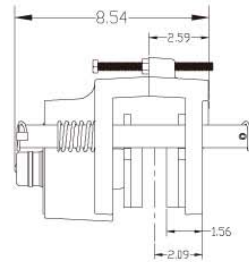
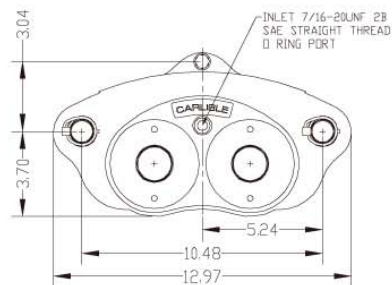

SCL70 SERIES BRAKES

Description

The Carlisle SCL70 series brake is a spring applied, hydraulically released (SAHR), single opposed piston, caliper disc brake designed for medium to high torque ranges. Both the caliper and disc require fixed mountings. Multiple calipers may be used on a single disc to proportionately increase torque output.

FEATURES

- Flexible mounting alternatives to accommodate numerous vehicle types
- Constructed from ductile iron casting for superior brake durability
- Equipped with Carlisle premium asbestos-free linings, providing superior stopping performance and life
- Optional seal materials available for compatibility with all actuation fluids and temperatures

APPLICATION

- Large surface mining haulage trucks

Specifications

Caliper Material	High-strength ductile iron
Mounting Attitude	9 o'clock
Maximum Pressure	3,000 psi (206.8 bar)
Minimum Pressure to Fully Retract	1,650 psi (114 bar)
Inlet Type	.4375-20 UNF
Lining Material	Non-asbestos, organic
Lining Area per Brake	6.68 in ² (43 cm ²)
Lining Volume per Brake	1.1 in ³ (18 cm ³)
Disc Thickness	.635 in (16.1 mm) and 1 in (25.4 mm)
Disc Diameter	19 in (482.6 mm) to unlimited
Displacement per Brake	.75 in ³ (12.3 cm ³)
Number of Pistons	2
Final Assembly Weight	84 lbs (38.1 kg)

Formulas

Torque (lbf-in) = Tangential Force (lbf) × Disc Friction Radius (in)
 Disc Friction Radius (in) = Disc Diameter (in) ÷ 2 - 1.12 (in)
 Tangential Force (lbf) = 14,000 lbf

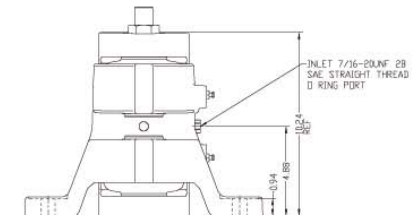
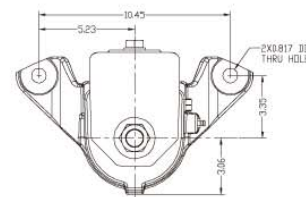

Brake Application Questionnaire



SALES REP :

DATE :

CUSTOMER INFORMATION

Company Name:	Telephone:
Contact:	E-Mail:
Address:	Fax:

APPLICATION INFORMATION

Vehicle Type:	Type of Brake (Dry Caliper, Drum, Wet):
Vehicle Model Number:	Actuation (Mechanical, Hydraulic, SAHR):
Approximate Annual Volume:	Actuation Fluid (Automotive Brake Fluid, Mineral Oil, Air):
Normal Brake Usage (Service, Park/Secondary):	Braking Standard to be Used:
Brake Location (Wheel, Drive Shaft):	

1 VEHICLE SPECIFICATIONS

Empty Vehicle Weight:	W empty		kg/lb
Gross Vehicle Weight:	W gross		kg/lb
Gear Reduction:	G eartotal	:	1 All gear reduction between the brake location and the vehicle ground contact.
	Gear Front wheel =		Gear Rear wheel =
Total Resistance:	R %	%	2% standard unless otherwise specified
Maximum Brake Pressure:			bar/psi
Number of Braked Wheels:	n wheel		
Tire Rolling Radius / Static:	R static	m/in	Hub O.D. m/in
Brake Clearance / Rim I.D.:		m/in	Thickness Front m/in Rear m/in
Disc Dimensions / O.D.:	Front	m/in	Disc I.D. Front m/in
	Rear	m/in	Rear m/in
Empty Weight Total:		T	of which front axle of which middle axle of which rear axle
Loaded Weight Total:		T	of which front axle of which middle axle of which rear axle

2 OPERATING SPECIFICATIONS

Grade Hold Requirement:	G static%	%
Maximum Level Surface Speed:	V max	kph/mph
Stop Distance Requirement:	S stop	m/ft
System Actuating Time Delay:	t delay	sec
Dynamic Grade Requirement:	G dyn%	%
Ground Coefficient:	μ ground	5 is typical ground coefficient for unmaintained loose earth.

COMMENTS

Brake Application Questionnaire



SALES REP :

DATE :

CUSTOMER INFORMATION

Company Name:	Telephone:
Contact:	E-Mail:
Address:	Fax:

APPLICATION INFORMATION

Vehicle Type:	Type of Brake (Dry Caliper, Drum, Wet):
Vehicle Model Number:	Actuation (Mechanical, Hydraulic, SAHR):
Approximate Annual Volume:	Actuation Fluid (Automotive Brake Fluid, Mineral Oil, Air):
Normal Brake Usage (Service, Park/Secondary):	Braking Standard to be Used:
Brake Location (Wheel, Drive Shaft):	

1 VEHICLE SPECIFICATIONS

Empty Vehicle Weight:	W empty	kg/lb
Gross Vehicle Weight:	W gross	kg/lb
Gear Reduction:	G overall	: 1 All gear reduction between the brake location and the vehicle ground contact.
Gear Front wheel =		Gear Rear wheel =
Total Resistance:	R %	% 2% standard unless otherwise specified
Maximum Brake Pressure:		bar/psi
Number of Braked Wheels:	n wheel	
Tire Rolling Radius / Static:	R static	m/in Hub O.D.
Brake Clearance / Rim I.D.:		m/in Thickness Front m/in Rear
Disc Dimensions / O.D.:	Front	m/in Disc I.D. Front m/in
	Rear	m/in Disc I.D. Rear m/in
Empty Weight Total:	T	of which front axle
		of which middle axle
		of which rear axle
Loaded Weight Total:	T	of which front axle
		of which middle axle
		of which rear axle

2 OPERATING SPECIFICATIONS

Grade Hold Requirement:	G static %	%
Maximum Level Surface Speed:	V max	kph/mph
Stop Distance Requirement:	S stop	m/ft
System Actuating Time Delay:	t delay	sec 3 sec will be used unless otherwise specified.
Dynamic Grade Requirement:	G dyn %	% 0% will be used unless otherwise specified.
Ground Coefficient:	μ ground	5 is typical ground coefficient for unmaintained loose earth.

COMMENTS

FAX: 0086 512 6805 0029 Email: CBF_AP_Marketing@carlislecbf.com

COMBO BRAKES

32 HDBC4225 BRAKE

- QUESTIONNAIRE



HDBC4225 BRAKE

Description

The Carlisle HDBC4225 series brake is a combination, service and park, triple opposed piston, caliper disc brake designed for dynamic and static applications. One set of opposed pistons is a spring applied, hydraulically released (SAHR) park brake while the other two sets of opposed pistons are a hydraulically actuated service brake. The service brake includes retracting springs and automatic adjusters. Both the caliper and disc require fixed mountings. This brake provides a high torque range for heavy-duty service conditions. Multiple calipers may be used on a single disc to proportionately increase torque output. Also available as a service brake only without the SAHR park brake.

FEATURES

- Flexible mounting alternatives to accommodate numerous vehicle and equipment types
- Constructed from ductile iron casting for superior brake durability
- Equipped with Carlisle premium asbestos-free linings, providing superior stopping performance and life
- Optional seal materials available for compatibility with all actuation fluids and temperatures

APPLICATION

- Electric drive rigid haul trucks
- Mobile construction and mining equipment

Specifications

	Service Brake	Park Brake
Caliper Material	High-strength ductile iron	High-strength ductile iron
Mounting Attitude	6, 12 o'clock	6, 12 o'clock
Maximum Pressure	3,000 psi (206.8 bar)	3,000 psi (206.8 bar)
Minimum Pressure	100 psi (6.9 bar)	1,650 psi (113.8 bar)
Inlet Type	.5625-18 UNF	.5625-18 UNF
Lining Material	Non-asbestos	Non-asbestos
Lining Area per Brake	102 in ² (658 cm ²)	102 in ² (658 cm ²)
Lining Volume per Brake	104 in ³ (1704 cm ³)	104 in ³ (1704 cm ³)
Disc Thickness	1.0 in (25.4 mm)	1.0 in (25.4 mm)
Disc Diameter Range	19 in (482.6 mm) to 31 in (787.4 mm)	19 in (482.6 mm) to 31 in (787.4 mm)
Displacement per Brake	2.5 in ³ (41.0 cm ³)	3.5 in ³ (57.4 cm ³)
Number of Pistons	4	2
Final Assembly Weigh	107.96 kg	107.96 kg

Formulas

English Units*

Service Brake

Torque (lb·in) = $K \times P \times X \times \text{Disc Friction Radius (in)}$
 Disc Friction Radius (in) = $\text{Disc Diameter (in)} \div 2 - 2.0$ (in)
 K (Dynamic) = 8.48
 P = Input Pressure = 100 (psi)

Park Brake

Torque (lb·in) = $\text{Tangential Force (lbf)} \times \text{Disc Friction Radius (in)}$
 Disc Friction Radius (in) = $\text{Disc Diameter (in)} \div 2 - 2.0$ (in)
 Tangential Force (lbf) = 6,850 or 8,750 lbf

* Torques calculated are based on dry friction coefficient and optimum lining break-in.

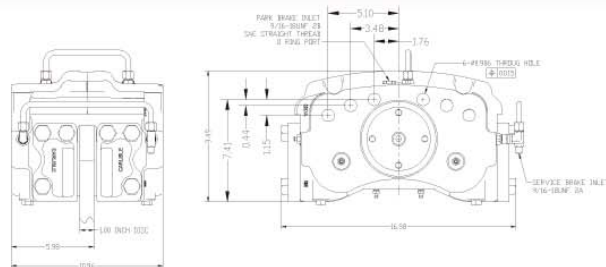

Brake Application Questionnaire



SALES REP :

DATE :

CUSTOMER INFORMATION

Company Name:	Telephone:
Contact:	E-Mail:
Address:	Fax:

APPLICATION INFORMATION

Vehicle Type:	Type of Brake (Dry Caliper, Drum, Wet):
Vehicle Model Number:	Actuation (Mechanical, Hydraulic, SAHR):
Approximate Annual Volume:	Actuation Fluid (Automotive Brake Fluid, Mineral Oil, Air):
Normal Brake Usage (Service, Park/Secondary):	Braking Standard to be Used:
Brake Location (Wheel, Drive Shaft):	

1 VEHICLE SPECIFICATIONS

Empty Vehicle Weight:	W empty	kg/lb
Gross Vehicle Weight:	W gross	kg/lb
Gear Reduction:	G overall	: 1 All gear reduction between the brake location and the vehicle ground contact.
Gear Front wheel =		Gear Rear wheel =
Total Resistance:	R %	% 2% standard unless otherwise specified
Maximum Brake Pressure:		bar/psi
Number of Braked Wheels:	n wheel	
Tire Rolling Radius / Static:	R static	m/in Hub O.D.
Brake Clearance / Rim I.D.:		m/in Thickness Front m/in Rear
Disc Dimensions / O.D.:	Front	m/in Disc I.D. Front m/in Rear
	Rear	m/in Disc I.D. Rear m/in
Empty Weight Total:	T	of which front axle of which middle axle of which rear axle
Loaded Weight Total:	T	of which front axle of which middle axle of which rear axle

2 OPERATING SPECIFICATIONS

Grade Hold Requirement:	G static %	%
Maximum Level Surface Speed:	V max	kph/mph
Stop Distance Requirement:	S stop	m/ft
System Actuating Time Delay:	t delay	sec 3 sec will be used unless otherwise specified.
Dynamic Grade Requirement:	G dyn %	% 0% will be used unless otherwise specified.
Ground Coefficient:	μ ground	.5 is typical ground coefficient for unmaintained loose earth.

COMMENTS

FAX: 0086 512 6805 0029 Email: CBF_AP_Marketing@carlislecbf.com

Brake Application Questionnaire



SALES REP :

DATE :

CUSTOMER INFORMATION

Company Name:	Telephone:
Contact:	E-Mail:
Address:	Fax:

APPLICATION INFORMATION

Vehicle Type:	Type of Brake (Dry Caliper, Drum, Wet):
Vehicle Model Number:	Actuation (Mechanical, Hydraulic, SAHR):
Approximate Annual Volume:	Actuation Fluid (Automotive Brake Fluid, Mineral Oil, Air):
Normal Brake Usage (Service, Park/Secondary):	Braking Standard to be Used:
Brake Location (Wheel, Drive Shaft):	

1 VEHICLE SPECIFICATIONS

Empty Vehicle Weight:	W _{empty}		kg/lb
Gross Vehicle Weight:	W _{gross}		kg/lb
Gear Reduction:	G _{overall}		: 1 All gear reduction between the brake location and the vehicle ground contact.
Gear Front wheel =		Gear Rear wheel =	
Total Resistance:	R %		% 2% standard unless otherwise specified
Maximum Brake Pressure:			bar/psi
Number of Braked Wheels:	n _{wheel}		
Tire Rolling Radius / Static:	R _{static}	m/in	Hub O.D. m/in
Brake Clearance / Rim I.D.:		m/in	Thickness Front m/in Rear
Disc Dimensions / O.D.:	Front	m/in	Disc I.D. Front m/in
	Rear	m/in	Rear m/in
Empty Weight Total:	T		of which front axle
			of which middle axle
			of which rear axle
Loaded Weight Total:	T		of which front axle
			of which middle axle
			of which rear axle

2 OPERATING SPECIFICATIONS

Grade Hold Requirement:	G _{static} %		%
Maximum Level Surface Speed:	V _{max}		kph/mph
Stop Distance Requirement:	S _{stop}		m/ft
System Actuating Time Delay:	t _{delay}	sec	3 sec will be used unless otherwise specified.
Dynamic Grade Requirement:	G _{dyn} %		0% will be used unless otherwise specified.
Ground Coefficient:	μ _{ground}		5 is typical ground coefficient for unmaintained loose earth.

COMMENTS

BOOSTER

34	BOOSTER	40	TANDEM TWIN BOOSTER
37	COMPACT TWIN BOOSTER	41	TANDEM SINGLE BOOSTER
38	COMPACT SINGLE BOOSTER	42	MASTER CYLINDER
39	MIDI TWIN BOOSTER	43	PRODUCT OVERVIEW
		-	QUESTIONNAIRE



Why Use A Boosted Master Cylinder (Booster) Instead of a Standard Master Cylinder?

Boosters Provide a Higher Output Pressure to The Brake System Resulting In

- A significant reduction in pedal effort and pedal travel to achieve the required operating pressure at the brake.
- A progressive and controllable braking response offering improved cabin ergonomics and enhanced operator comfort.
- A more efficient method of applying the brakes on Off-Highway vehicles.

BOOSTERS require much less input force to achieve Normal Operating Pressure

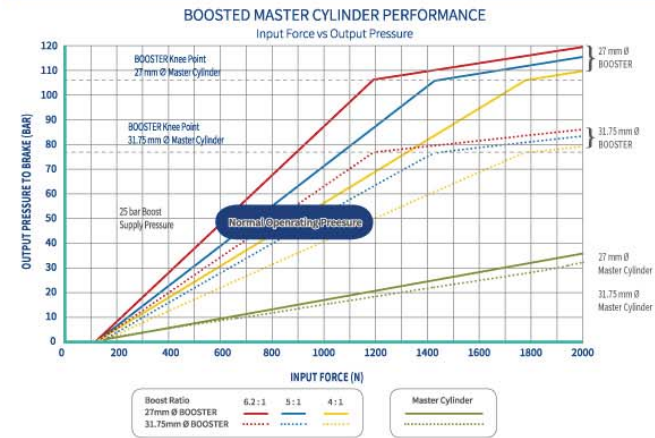

To achieve the same Pedal Force a Carlisle BOOSTER requires much less pedal travel than a standard master cylinder.

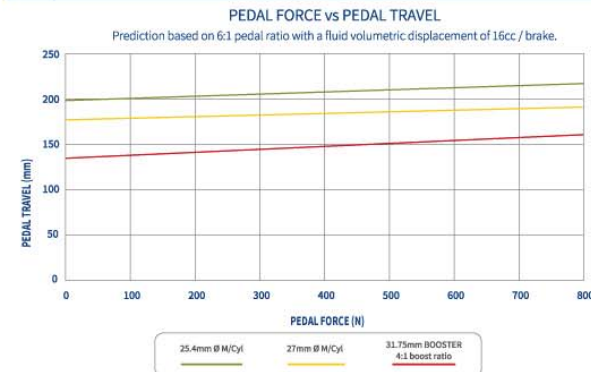

EXPORT PRODUCT AND TECHNOLOGY TRENDS



MIDI TWIN BOOSTER



COMPACT TWIN BOOSTER

- Drivers demand 'Luxury Car' performance from brake & clutch systems for Off-Highway vehicles
- Increasing horsepower, speed and weight requirements in Europe and North America have led to;
 - ✧ Truck legislation imposed on vehicles operating at > 50kph
 - ✧ Increasing brake running clearance reduces brake drag, resulting in improved fuel efficiency and lower operating costs
 - ✧ Braking required on all four wheels
 - ✧ Balanced braking across axles

BOOSTER

Braking System Diagrams

TYPICAL TRACTOR BRAKING SYSTEM

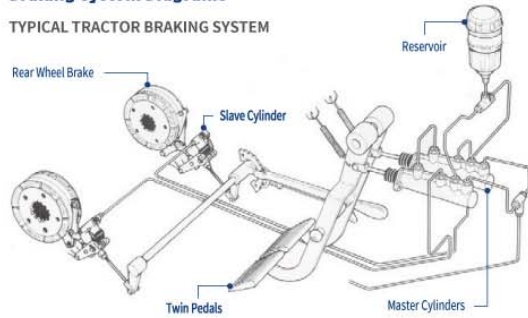

Most tractor brake systems use MINERAL oil, but some use VEGETABLE (Glycol) synthetic fluid as used by passenger cars — it is very important that the seals of either are not mixed

CARLISLE TWIN BOOSTER APPLICATION

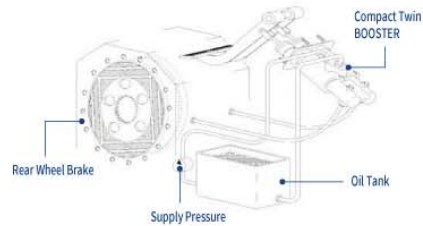

CARLISLE TANDEM TWIN BOOSTER APPLICATION

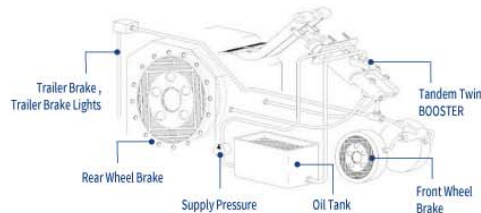

Application Ranges



BOOSTER

Comfort And Safety 

BENEFIT of a Carlisle BOOSTER

- A wide range of boost ratios and master cylinder diameters can be used to tailor the performance to meet the customer's exact requirements.
- Provides a progressive and controllable braking response by optimising the "pedal feel" and improving driver comfort and cabin ergonomics.
- Use of PTFE seal technology provides high wear resistance and extended durability life. One million cycles achieved with no deterioration of product.
- Self-bleed feature allows any air ingress in the master cylinders to be vented to the tank chamber during normal operation.
- No additional reservoir required: The master cylinder and BOOSTER use a common oil supply thus preventing the cross contamination of fluids or potential ingress of debris.
- Significant reduction in warranty issues.
- Closed centre BOOSTER design minimizes oil usage.
- Uses the existing vehicle power hydraulic system to provide servo assist to the master cylinder.
- Patented design for twin or single pedal brake systems.
- Significant cost advantage compared to Power Valve products.
- Ease of installation — only four hydraulic connections required.
- Various mounting plate and push rod options available.



COMPACT TWIN BOOSTER



COMPACT SINGLE BOOSTER



MIDI TWIN BOOSTER



TANDEM TWIN BOOSTER



TANDEM SINGLE BOOSTER



MASTER CYLINDER

COMPACT TWIN BOOSTER



Patented closed circuit design with integrated master cylinder BOOSTER and reservoir in a single component.

- Patented design for mineral oil twin pedal braking systems providing a boosted, progressive pedal feel.
- Generic design enables performance to be easily matched to most agricultural and industrial vehicle applications.
- Self-bleed design keeps BOOSTER purged of any ingressed air.
- PTFE seal technology ensures extended service life.
- No reservoir required — uses supply oil for braking systems.
- Range of metric or imperial ports — to international standards — available.
- Large variety of pushrod lengths and thread sizes available. *
- Clevis options available to suit customer requirements.

Specifications

Body Length	Less than 205 mm	Range of Diameters	25.4 mm to 57 mm
Oil	Mineral Oil	Supply Pressure	15 bar to 40 bar
Tested to	1,000,000 Cycles	Minimum Flow Rate	10 L/min
BOOSTER Ratio	2.65, 4, 5 and 6.2:1	Operation Temperature	-30°C to 100°C

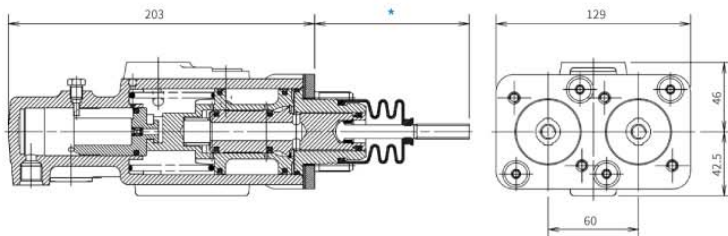

COMPACT SINGLE BOOSTER

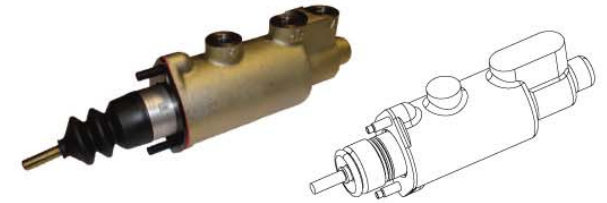

Patented closed circuit design with integrated master cylinder, BOOSTER and reservoir in a single component.

- Patented design for mineral oil single pedal braking systems, providing a boosted, progressive pedal feel.
- Ideal for clutch applications.
- Generic design enables performance to be easily matched to most agricultural and industrial vehicle applications.
- Self-bleed design keeps BOOSTER purged of any ingressed air.
- PTFE seal technology ensures extended service life.
- No reservoir required — uses supply oil for braking or clutch systems.
- Range of metric or imperial ports — to international standards — available.
- Large variety of pushrod lengths and thread sizes available. *
- Clevis options available to suit customer requirements.

Specifications

Body Length	Less than 200 mm	Range of Diameters	25.4 mm to 41 mm
Oil	Mineral Oil	Supply Pressure	15 bar to 40 bar
Tested to	1,000,000 Cycles	Minimum Flow Rate	10 L/min
BOOSTER Ratio	2.65, 4, 5 and 6.2:1	Operation Temperature	-30°C to 100°C

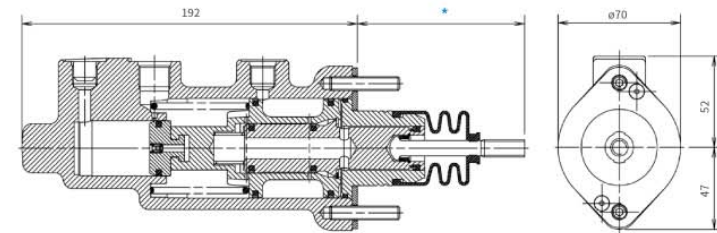

MIDI TWIN BOOSTER



Simplified design reduced weight and smaller size give cost advantages over larger BOOSTERS in the Carlisle BOOSTER family.

- Patented design for mineral oil twin pedal braking systems providing a boosted, progressive pedal feel.
- Generic design enables performance to be easily matched to most agricultural and industrial applications.
- Self-bleed design keeps BOOSTER purged of any ingressed air.
- PTFE seal technology ensures extended service life.
- No reservoir required — uses supply oil for braking systems.
- Range of metric or imperial ports — to international standards — available.
- Large variety of pushrod lengths and thread sizes available. *
- Clevis options available to suit customer requirements.

Specifications

Body Length	Less than 175 mm	Supply Pressure	15 bar to 40 bar
Oil	Mineral Oil	Minimum Flow Rate	10 L/min
Tested to	1,000,000 Cycles	Operation Temperature	-30°C to 100°C
BOOSTER Ratio	3, 4 and 5:1	Vehicle Horsepower*	80 HP to 130 HP
Range of Diameters	25.4 mm to 30 mm		

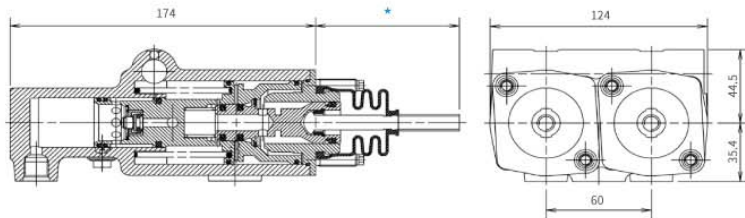

TANDEM TWIN BOOSTER



BRAKING CAPABILITIES:

- ※ Pressure Balanced
- ※ Independent
- ※ Dual-circuit
- ※ Designed for twin pedal vehicles with four independent brakes with trailer brake option.

- Patented design for mineral oil twin pedal braking systems providing a boosted, progressive pedal feel.
- Generic design enables performance to be easily matched to most agricultural and industrial vehicle applications.
- Self-bleed design keeps BOOSTER purged of any ingressed air.
- PTFE seal technology ensures extended service life.
- No reservoir required — uses supply oil for braking systems.
- Range of metric or imperial ports — to international standards — available.
- Large variety of push rod lengths and thread sizes available. *
- Clevis options available to suit customer requirements.

Specifications

Body Length	Less than 230 mm	Range of Diameters	25.4 mm to 35 mm
Oil	Mineral Oil	Supply Pressure	15 bar to 40 bar
Tested to	1,000,000 Cycles	Minimum Flow Rate	10 L/min
BOOSTER Ratio	2.65, 4, 5 and 6:1	Operation Temperature	-30°C to 100°C

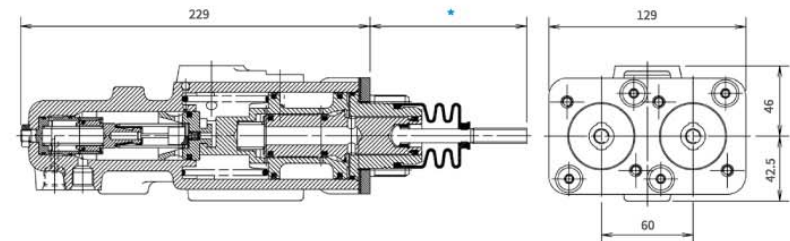

TANDEM SINGLE BOOSTER



BRAKING CAPABILITIES:

- ※ Independent ※ Dual-circuit
- ※ Designed for single pedal vehicles with split circuit braking.

- Patented design for mineral oil single pedal braking systems providing a boosted, progressive pedal feel.
- Generic design enables performance to be easily matched to most construction and industrial vehicle applications.
- Self-bleed design keeps BOOSTER purged of any ingressed air.
- PTFE seal technology ensures extended service life.
- No reservoir required — uses supply oil for braking systems.
- Range of metric or imperial ports — to international standards — available.
- Large variety of push rod lengths and thread sizes available. *
- Clevis options available to suit customer requirements.

Specifications

Body Length	Less than 220 mm	Range of Diameters	25.4 mm to 44 mm
Oil	Mineral Oil	Supply Pressure	15 bar to 40 bar
Tested to	1,000,000 Cycles	Minimum Flow Rate	10 L/min
BOOSTER Ratio	3, 4 and 5:1	Operation Temperature	-30°C to 100°C

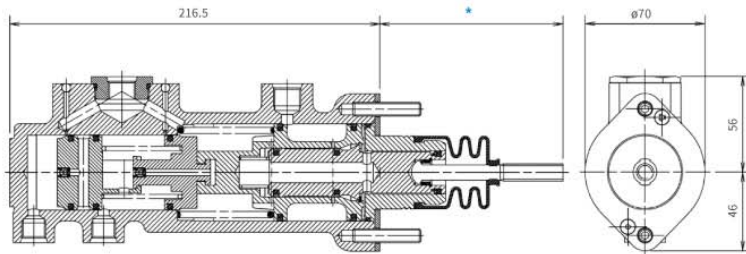

MASTER CYLINDER



- Designs for single and twin pedal applications.
- Twin pedal cylinders feature proven compensation design for dual circuit pressure balance.
- New self-bleed design features PTFE sealing for improved life and continuous air expulsion.
- Designed to meet a range of operating pressures and temperatures.
- Large variety of pushrod lengths and thread sizes. *
- Range of metric or imperial ports — to international standards — available.
- Clevis options available to suit customer requirements.

Specifications

Oil	Mineral and Glycol (DOT3, 4)	Range of Diameters	15.8 mm to 31.75 mm
-----	------------------------------	--------------------	---------------------

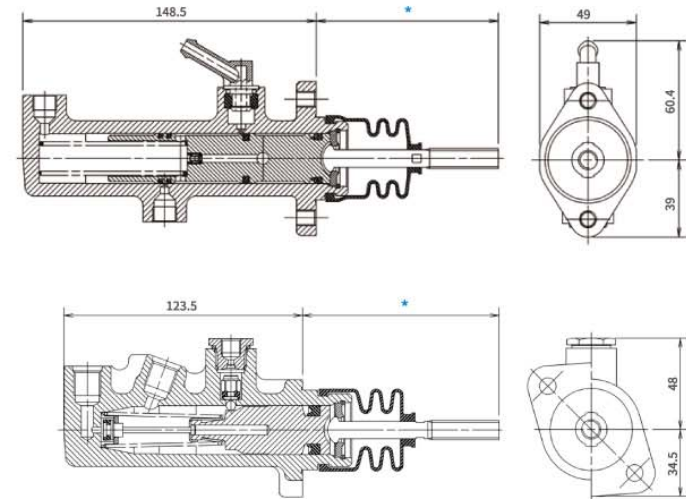

PRODUCT OVERVIEW

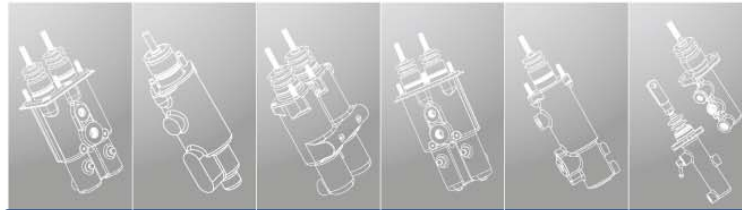

	COMPACT TWIN BOOSTER	COMPACT SINGLE BOOSTER	MIDI TWIN BOOSTER	TANDEM TWIN BOOSTER	TANDEM SINGLE BOOSTER	MASTER CYLINDER
BOOSTER Capability	Integrated	Integrated	Integrated	Integrated	Integrated	Requires separate system
Boost Ratio Available	2.6, 4.0, 5.0 and 6.2:1	2.6, 4.0, 5.0 and 6.2:1	3.2, 4.0 and 5.2:1	2.6, 4.0, 5.0 and 6.2:1	3, 4 and 5:1	Not Applicable
Master Cyl Diameter	27.0, 31.75 and 57.0	31.75, 35.0 and 41.0	25.4, 27.0 and 30.0	35	25.4 and 44	15.8, 19.0, 22.2, 25.4 and 27.0
Master Cyl Stroke	35.0 and 30.0	35	35	35	17.5 / 17.5	35
Master Cyl Displacement Available (cc)	20.0, 27.0 and 76.0	27.0, 33.0 and 45.0	15.1, 17.1 and 21.1	Variable, dependent on Front / Rear requirements	24.3 / 24.3	6.85, 9.91, 13.05, 17.75 and 20.02
Compensation Available (%)	25% to 50% and 100%	N/A	100% only	Variable, dependent on Front / Rear requirements	N/A	N/A
Length mm	202	192	175	230	220	Various
Closed Circuit	✓	✓	✓	✓	✓	✗
Reservoir Required	✗	✗	✗	✗	✗	✓
Closed Center	✓	✓	✓	✓	✓	✗
Simple Installation	✓	✓	✓	✓	✓	✓
Steer Turn Facility	✓	✗	✓	✓	✗	✗
Modular Design	✓	✓	✓	✓	✓	✗
Reduced System Complexity	✓	✓	✓	✓	✓	✗
Self-Bleed	✓	✓	✓	✓	✓	✗
Glycol (DOT4) / Mineral Oil	Mineral	Mineral	Mineral	Mineral	Mineral	Mineral / Glycol (DOT4)

Booster / Master Cylinder Application Questionnaire



SALES REP:

DATE:

Vehicle type (e.g. Tractor, Backhoe loader): _____
 Model designation: _____
 Single or twin pedal: _____
 Brake oil type (mineral or glycol based): _____
 Master cylinder or booster: _____
 Legislation (e.g. ISO3450): _____
 Customer preferred pedal effort/
 travel for given deceleration (if known): _____

Pedal ratio: _____
 Boost supply pressure (36 bar max): _____
 Hydraulic pressure required at brakes * : _____
 Brake volumetric consumption (per brake) * : _____

Due to the complexity of different braking systems within the agricultural and industrial vehicle market, please supply a diagram/sketch of the braking system required.

*** If this is not known then the vehicle and brake technical data is required**

Vehicle unladen weight: _____
 Vehicle gross vehicle weight: _____
 Rear and front tyre rolling radii: _____
 Brake: wheel gear reduction ratio: _____
 Annular piston internal diameter: _____
 Annular piston external diameter: _____
 Friction material internal diameter: _____
 Friction material external diameter: _____
 Quantity of friction discs / brake: _____
 Friction coefficient: _____
 Friction material name: _____
 Running clearance / brake face: _____

If the brakes are not the annular piston design, then please contact Carlisle technical department to discuss the specific requirements.

Booster / Master Cylinder Application Questionnaire

SALES REP:

DATE:

Vehicle type (e.g. Tractor, Backhoe loader): _____
 Model designation: _____
 Single or twin pedal: _____
 Brake oil type (mineral or glycol based): _____
 Master cylinder or booster: _____
 Legislation (e.g. ISO3450): _____
 Customer preferred pedal effort/
 travel for given deceleration (if known): _____

Pedal ratio: _____
 Boost supply pressure (36 bar max): _____
 Hydraulic pressure required at brakes*: _____
 Brake volumetric consumption (per brake)*: _____

Due to the complexity of different braking systems within the agricultural and industrial vehicle market, please supply a diagram/sketch of the braking system required.

*** If this is not known then the vehicle and brake technical data is required**

Vehicle unladen weight: _____
 Vehicle gross vehicle weight: _____
 Rear and front tyre rolling radii: _____
 Brake: wheel gear reduction ratio: _____
 Annular piston internal diameter: _____
 Annular piston external diameter: _____
 Friction material internal diameter: _____
 Friction material external diameter: _____
 Quantity of friction discs / brake: _____
 Friction coefficient: _____
 Friction material name: _____
 Running clearance / brake face: _____

If the brakes are not the annular piston design, then please contact Carlisle technical department to discuss the specific requirements.

HYDRAULIC CONTROL

- 45 1100 SERIES - QUESTIONNAIRE
- 47 2100 SERIES
- 49 DUAL CIRCUIT ADJUSTERS
- 50 SINGLE CIRCUIT ADJUSTERS



1100 SERIES

Description

The Carlisle single and tandem circuit, modulating hydraulic control valves are made of ductile cast iron bodies. The valves are capable of providing modulating output pressures to a maximum 3,500 psi (24,133 kPa).

FEATURES

- Flow capabilities exceed competitive designs
- Spool design provides smooth modulation at all output pressures
- Dampened spools for stable, noise-free operation
- Externally adjustable to provide precise pressure settings
- Rugged construction for most severe job applications
- Thoroughly tested to ensure superior performance and durability
- Automotive style pedal feedback

APPLICATION

- Hydraulically actuated, single and tandem circuit braking and industrial systems where high quality, precise modulation is required.

Options

- Vertical and horizontal treadle actuator with adjustable pedal angle and pedal travel
- Horizontally mounted suspended pedal actuator
- 90° porting orientation intervals for vertically mounted valves
- 180° porting orientation intervals for horizontally mounted treadle valves
- Hydraulic pilot apply
- Pressure-adjustable stoplight switch for mobile applications
- Heavy or medium pedal force selection
- SAE porting
- Staged pressure rise for precise control

Specifications

- Body Material: Ductile iron
- Seal Material: Nitroxil® compound
- Maximum Input Pressure: 3,500 psi (24,133 kPa)
- Maximum Output Pressure: 3,500 psi (24,133 kPa)

DRAWINGS

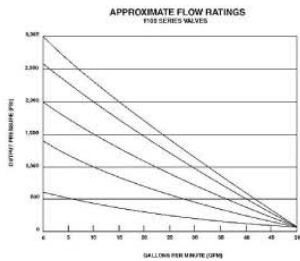

Input / Output Performance Curve

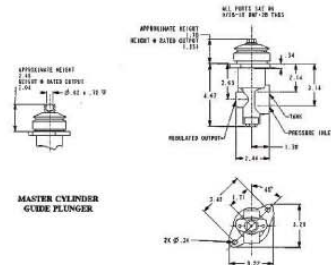

Master Cylinder Guide Plunger

1100 SERIES

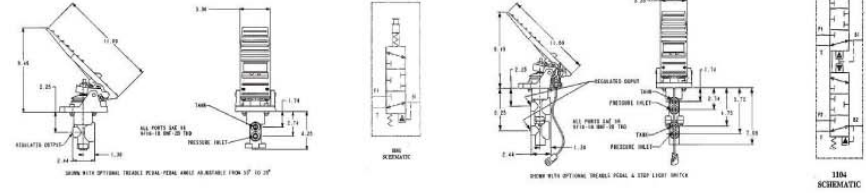

1101 Valve Series

1101 Valve Schematic

1104 Valve Series

1104 Valve Schematic

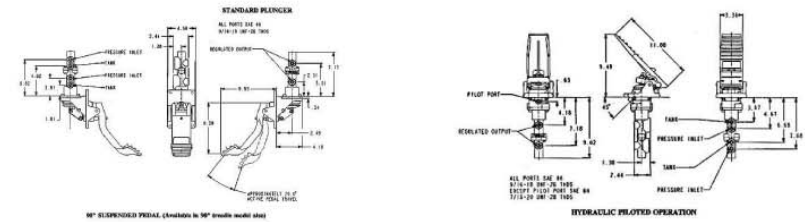

90° Suspended Pedal

Hydraulic-Piloted Operation

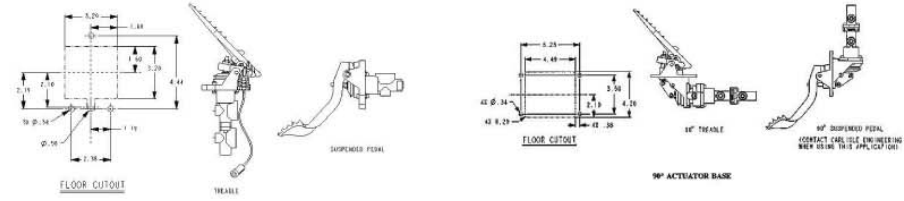

Standard Actuator Base Floor Cutout

90° Actuator Base Floor Cutout

2100 SERIES

Description

The Carlisle single circuit (2101) and parallel (2102) circuit, modulating hydraulic control valves are capable of providing modulating output pressures in a range of 600 psi - 3,500 psi (4,137 kPa to 24,133 kPa).

FEATURES

- Spool sleeve design allows for easy serviceability and reduced maintenance costs
- Spool design provides smooth modulation at all output pressures
- Valve is externally adjustable to provide precise pressure settings
- Large supply and return ports provide high flow capabilities versus competitive designs
- Automotive style pedal feedback
- Standard pilot apply (optional on the 2101 series)
- Rugged construction and thorough testing ensure superior performance and endurance for even the most severe job applications
- Pedal angle fully adjustable
- Dampened spools for stable noise control

APPLICATION

- Hydraulically actuated, single and tandem circuit braking and industrial systems where high quality, precise modulation is required.

Options

- Treadle actuator with adjustable pedal angle
- Circuit staging to provide non-linear output pressure
- Unequal output pressure on "B1" and "B2" (2102 series)
- Adjustable stoplight switch
- Available with or without pedal/actuator, or lever actuator with friction detent option (2101 series)
- Firewall mounted, suspended pedal
- Dual pilots for separate circuit control
- Externally adjustable differential pressure warning switch
- SAE or metric ports

Specifications

- Body Material: High strength aluminum
- Seal Material: Nitroxile® compound
- Maximum Input Pressure: 3,500 psi (24,133 kPa)
- Maximum Output Pressure: 600 psi - 3,500 psi (4,137kPa - 24,133 kPa)

DRAWINGS

APPROXIMATE FLOW RATINGS
2100 SERIES VALVES

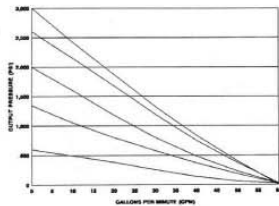

Input / Output Performance Curve

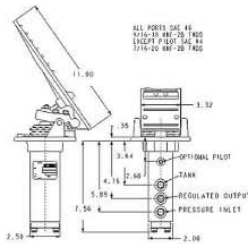

2101 Valve Series

2100 SERIES

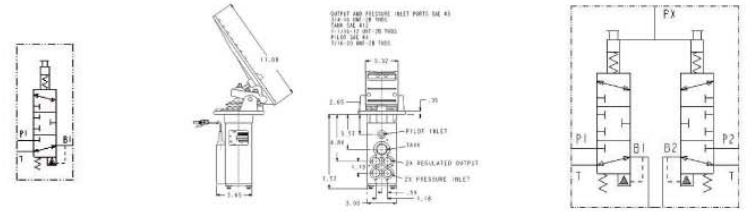

2101 Valve Schematic

2102 Valve Series

2102 Valve Schematic

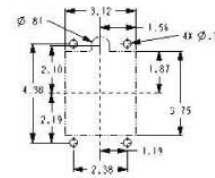

2100 SERIES
PEDAL CONTROL
FLOOR CUTOUT

2100 Series Pedal Control Floor Cutout

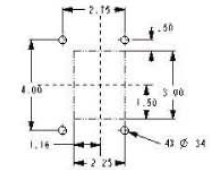

2100 SERIES
LEVER CONTROL
CONSOLE CUTOUT

2100 Series Lever Control Console Cutout

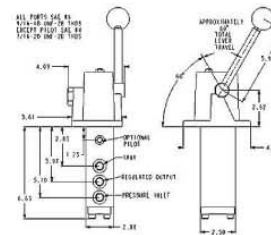

2100 Lever Valve Series

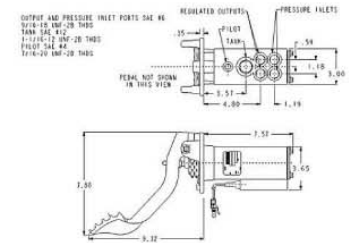

2100 Suspended Pedal Series

DUAL CIRCUIT ADJUSTERS

Description

Contact Carlisle for information about other available displacements

The automatic adjusters are used for in-line adjustment of high displacement hydraulic brakes. The adjuster functions to provide running clearance at each brake application. In drum brake applications the adjuster also compensates for clearance reduction due to thermal contraction of the brake.

Dual Circuit

Capacity		A	
IN ³	CM ³	IN	CM
3.5-3.5	57-57	6.8	173
6.0-6.0	98-98	7.3	185
10.0-10.0	164-164	8.2	208
12.0-12.0	197-197	8.3	211
15.7-15.7	257-257	9.7	246

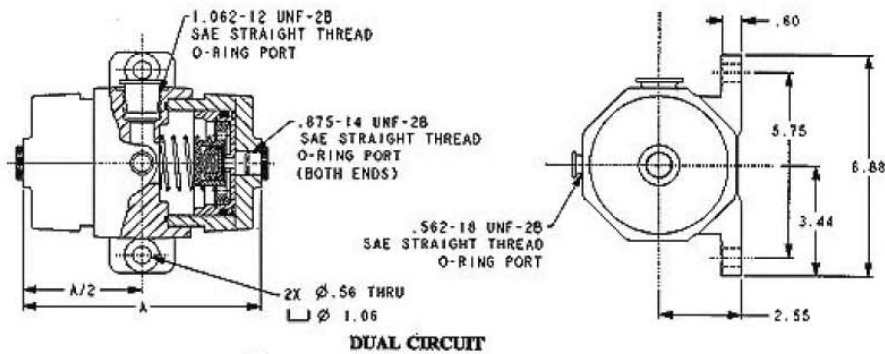

SINGLE CIRCUIT ADJUSTERS

Description

Contact Carlisle for information about other available displacements

The automatic adjusters are used for in-line adjustment of high displacement hydraulic brakes. The adjuster functions to provide running clearance at each brake application. In drum brake applications the adjuster also compensates for clearance reduction due to thermal contraction of the brake.

Single Circuit

Capacity		A	
IN ³	CM ³	IN	CM
3.5	57	3.7	94
6.0	98	3.7	94
10.0	164	3.7	94
16.0	262	5.2	132
19.0	311	12.4	315

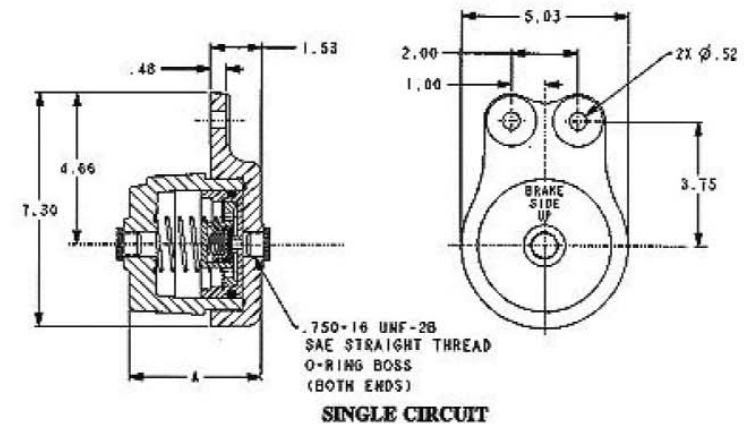

Hydraulic Control Application Questionnaire



SALES REP:

DATE:

CUSTOMER INFORMATION

Company Name:	Telephone:
Contact:	E-Mail:
Address:	Fax:

APPLICATION INFORMATION

Normally used in conjunction with SAHR park brakes

Vehicle Model:	Part Number:
Estimated Annual Quantity:	Sub Assembly Number:
Brake Valve Series:	1100 / 2100
Input Pressure bar:	
B1 Output Pressure bar:	
B2 Output Pressure bar:	
Reverse Modulation:	Yes / No

BRAKE VALVE OPTION

* Available on 1100 Series Only * Available on 2100 Series Only

Actuator Type:	Treadle, suspended pedal, **lever, none
----------------	---



Treadle



Suspended Pedal



Lever

Dead Band:	2 / 5 degree	Amount of pedal movement to full pressure apply
Pedal Travel:	13 / 18 degree	Amount of pedal movement to full pressure apply
Port Orientation:	0 / 180 degree	
Initial Pedal Angle:	28 / 60 degree	Applies to Treadle type only
Pedal Force (N):		Amount of pedal force required for full pressure apply
Pilot Operation:		The pilot feature allows for operation with a remote hydraulic signal
Port Threads:	English, *metric	* Metric only available on 1100 Series Valves
Proximity Switch:	Yes / No	Integrated stop light switch
Integral Port for Pressure Switch:	Yes / No	Available port for pressure switch
**Differential Pressure Switch:	Yes / No	Provides more pedal travel at low pressures and reduced travel at high pressure for quick apply
Pressure Setting bar:		
Staging:	Yes / No	Provides more pedal travel at low pressures and reduced travel at high pressure for quick apply
Staging Point bar:		
**Bias:	Yes / No	
Bias Lead Circuit:	B1 / B2	Bias will begin brake apply of one circuit before the other
Lead Pressure bar:		

COMMENTS

Hydraulic Control Application Questionnaire



SALES REP:

DATE:

CUSTOMER INFORMATION

Company Name:	Telephone:
Contact:	E-Mail:
Address:	Fax:

APPLICATION INFORMATION

Normally used in conjunction with SAHR park brakes

Vehicle Model:	Part Number:
Estimated Annual Quantity:	Sub Assembly Number:
Brake Valve Series:	1100 / 2100
Input Pressure bar:	
B1 Output Pressure bar:	
B2 Output Pressure bar:	
Reverse Modulation:	Yes / No

BRAKE VALVE OPTION

* Available on 1100 Series Only * Available on 2100 Series Only

Actuator Type:	Treadle, suspended pedal, **lever, none
----------------	---



Treadle



Suspended Pedal



Lever

Dead Band:	2 / 5 degree	Amount of pedal movement to full pressure apply
Pedal Travel:	13 / 18 degree	Amount of pedal movement to full pressure apply
Port Orientation:	0 / 180 degree	
Initial Pedal Angle:	28 / 60 degree	Applies to Treadle type only
Pedal Force (N):		Amount of pedal force required for full pressure apply
Pilot Operation:		The pilot feature allows for operation with a remote hydraulic signal
Port Threads:	English, *metric	* Metric only available on 1100 Series Valves
Proximity Switch:	Yes / No	Integrated stop light switch
Integral Port for Pressure Switch:	Yes / No	Available port for pressure switch
**Differential Pressure Switch:	Yes / No	Provides more pedal travel at low pressures and reduced travel at high pressure for quick apply
Pressure Setting bar:		
Staging:	Yes / No	Provides more pedal travel at low pressures and reduced travel at high pressure for quick apply
Staging Point bar:		
**Bias:	Yes / No	
Bias Lead Circuit:	B1 / B2	Bias will begin brake apply of one circuit before the other
Lead Pressure bar:		

COMMENTS

WET FRICTION

52	WET FRICTION	58	N-670 CARBON PAPER
55	N-266 PAPER	59	S-156 BRONZE
56	N-269 PAPER	60	S-154 BRONZE
57	N-401 PAPER	-	QUESTIONNAIRE



WET FRICTION

The Wet Friction Advantage

- Longer Life
- Non sparking
- Dual-use as retarder
- Less wear
- Immunity to dirt
- Smooth operation
- High energy and power capability
- Less noise

WET FRICTION SYSTEM

VS

DRY FRICTION SYSTEM

Wet

- Temperature capacity of 235°C due to oil degradation (Short term: 540°C)
- Static pressure: 6.9 Mpa gross facing area
- Energy capacity dependent upon heat sink and oil flow
- Low coefficient of friction~0.1

Dry

- Temperature capacity of melting point of material
- Static pressure: 27.5 Mpa gross facing area
- Energy capacity dependent upon heat sink only
- High coefficient of friction~0.4

CARLISLE N-670 PAPER

VS

LOCAL CHIANESE PAPER

PAPER - Average Wear Comparison

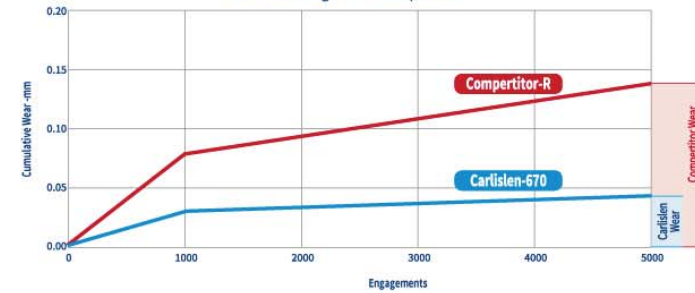

Under the same operating conditions, and after 5000 engagements, the competitor's product has worn 3 times more than Carlisle N-670.

CARLISLE S-156 BRONZE

VS

LOCAL CHIANESE BRONZE

BRONZE - Dynamic Coefficient of Friction Comparison

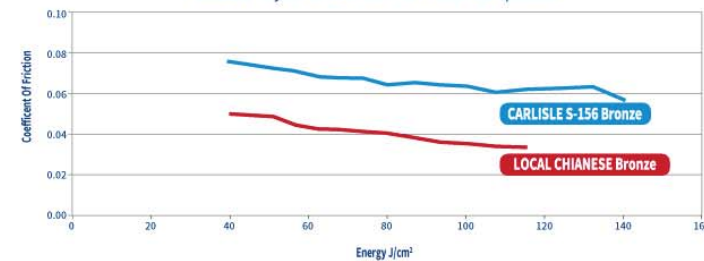

Under the same operating conditions, Carlisle S-156 bronze will maintain a 60% higher dynamic coefficient of friction. The local competitor's bronze will experience long slip times, high wear and distortion. The Carlisle Bronze S-156 is able to maintain a higher friction coefficient.

WHY REPLACE YOUR EXISTING FRICTION WITH CARLISLE PAPER FRICTION?

CARLISLE PAPER FRICTION MATERIALS OFFER MANY ADVANTAGES COMPARED TO BRONZE

- A Higher coefficient of friction
- Higher energy absorption
- Lower cost
- Lower weight
- Better shifting and braking characteristics
- Carlisle offers many paper grades for various applications

When moving from a bronze to a paper solution, the increase in coefficient of friction will either improve the torque output OR will allow the axle / transmission designer to reduce the apply force, the diameter of the friction disc, or the quantity of the friction discs. This results in a smaller more cost effective friction system.

	Bronze	Paper			
Coefficient of Friction	0.08	0.14	0.14	0.14	0.4
Torque N-m	600	600	600	600	1050
Force N	5000	5000	5000	2875	5000
N # surfaces	10	10	6	10	10
Mean radius (cm)	15	8	15	15	15
Effect	Standard Bronze	Smaller diameter	Fewer discs	Smaller diameter	Greater torque output

Design can be done knowing that the energy capacity and coefficient of friction will be greatly improved by up to twice that of bronze as seen by the following charts.

Carlisle Friction - Energy Capacity

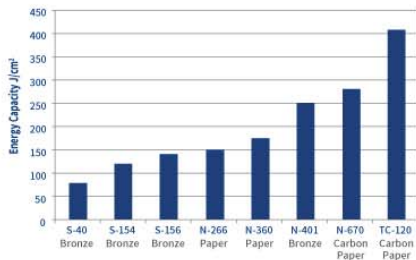

Carlisle Friction - Friction Level

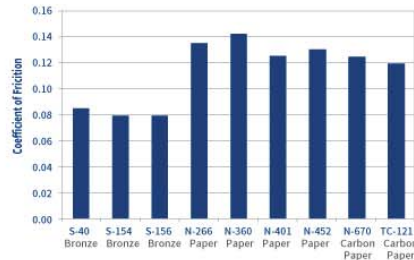

Carlisle's paper friction material has been the material of choice of all the leading global mining, construction and tractor manufacturers in the USA, Europe, Japan and Korea for many years. These applications range from transmissions and brakes to PTO's and differentials and everything in between.



Carlisle offers a full range of steel reaction plates. It is strongly recommended that to assure the optimum performance for each application a Carlisle friction couple of friction and steel be used together.

CARLISLE SOLUTIONS & RECOMMENDATIONS

Carlisle is renowned for providing innovative friction solutions for Original Equipment Manufacturers (OEM's) around the globe. Our superior friction technology, advanced application engineering and progressive manufacturing techniques provide substantial benefits to our manufacturing partners.

Sample Development Process

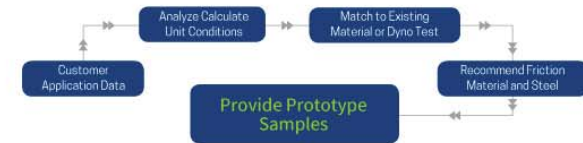

Solutions To Control Peak Temperature At The Interface

Appropriate clutch pack cooling needed:

- Proper oil feed system
- Oil flow and distribution
- Appropriate groove pattern
- Suitable friction material
- Good thermal heat sink

Application parameters such as vehicle weight, speed and duty cycle are measured and a material is selected that best fits the unitized operation parameters as indicated below:

Operating Condition	Low	Medium	High
Apply Load - MPa	1	4	>8
Energy - J/cm ²	50	100	>160
Oil flow - l/min/cm ²	0.003	0.009	>0.018

OIL FACTORS

The type of oil used can have a significant impact on friction material performance. Oil flow can be critical to friction material life. Carlisle is capable of designing with different friction materials to meet specific applications of oil.

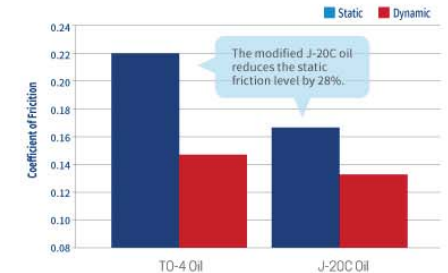

OIL FACTORS

Grooving is important in facilitating cooling of the friction surface between engagement cycles. Keeping the friction surface properly cooled leads to stability in the coefficient of friction and avoids clutch pack distortion. Cooling is necessary for efficient energy dissipation, and to maintain a uniform heat distribution on the steel reaction plate. The type of groove pattern can also influence parasitic drag. Carlisle engineers can help select the correct groove pattern for your application.

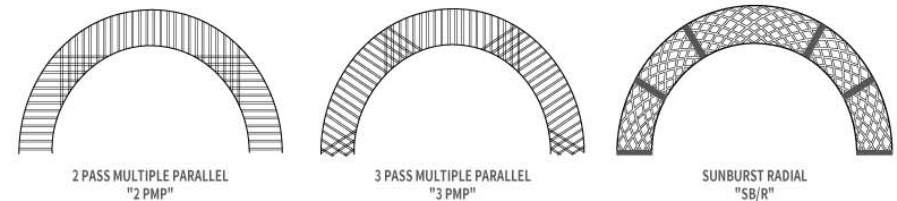

N-266 PAPER



Available in a range of thicknesses and oil groove patterns.

This is an oil cooled friction material with a moderately high energy capacity; moderately high dynamic coefficient of friction; a positive lockup and has a resistance to rougher opposing surfaces. This material is well suited for powershift transmission and wet brake applications. It has a tolerance to operate under very high unit loading.

SPEED TEST TO-4 OIL

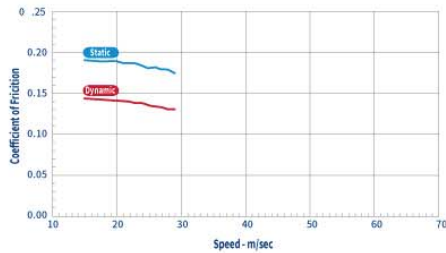

DURABILITY TEST TO-4 OIL

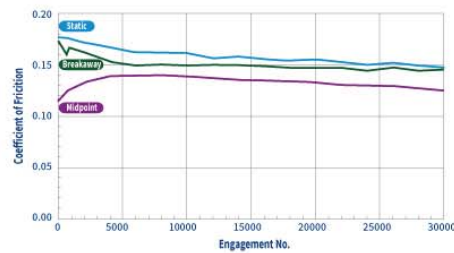

General Data

Recommended opposing surface: Steel up to 80 microinch Ra

Energy Capacity	150 J/cm ²	Max. Overload	8.3 Mpa
Power Capacity	85 W/cm ²	Avg. Dynamic Mu	0.100 - 0.140 oil dependent
Max. Continuous Load	5.5 Mpa	Avg. Static Mu	0.150 - 0.190 oil dependent

N-269 PAPER



Available in a range of thicknesses and oil groove patterns.

This is an oil cooled friction material with a moderately high energy capacity and dynamic coefficient of friction. This material possesses a very high static friction level aimed at applications such as limited slip differentials and load type clutches. It also sees use as a wet parking brake due to the high static friction level.

SPEED TEST TO-4 OIL

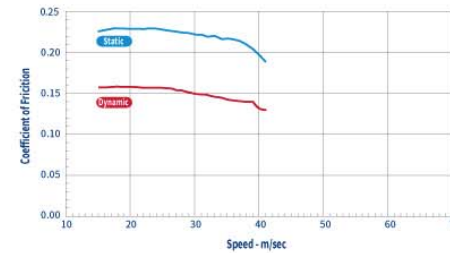

DURABILITY TEST TO-4 30 WGT OIL

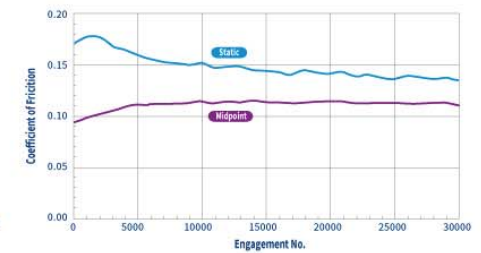

General Data

Recommended opposing surface: Steel up to 80 microinch Ra

Energy Capacity	170 J/cm ²	Max. Overload	8.2 Mpa
Power Capacity	92 W/cm ²	Avg. Dynamic Mu	0.100 - 0.140 oil dependent
Max. Continuous Load	5.5 Mpa	Avg. Static Mu	0.160 - 0.220 oil dependent

N-401 PAPER



Available in a range of thicknesses and oil groove patterns.

This is an oil cooled friction material with high energy capacity and coefficient of friction used primarily in powershift and counter shaft transmission designed for a positive lockup. This material has shown the ability to survive extreme conditions that has destroyed most resilient organic materials.

SPEED TEST TO-4 OIL

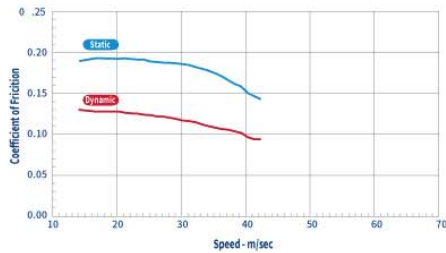

DURABILITY TEST TO-4 OIL

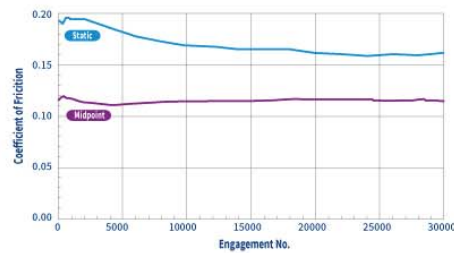

General Data

Recommended opposing surface: Steel up to 20 microinch Ra

Energy Capacity	250 J/cm ²	Max. Overload	5.5 Mpa
Power Capacity	144 W/cm ²	Avg. Dynamic Mu	0.110 - 0.140 oil dependent
Max. Continuous Load	2.75 Mpa	Avg. Static Mu	0.150 - 0.190 oil dependent

N-670 CARBON PAPER



Available in a range of thicknesses and oil groove patterns.

This oil cooled friction material is a carbon rich paper type material with the ability to withstand high unit loading of up to 5.5Mpa in dynamic applications. This material displays high heat capability and conforms uniformly onto the opposing plate. Smooth engagement characteristics are an added benefit.

SPEED TEST TO-4 OIL

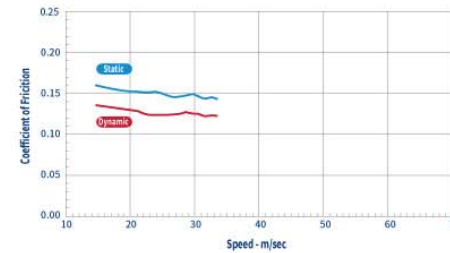

DURABILITY TEST TO-4 30 WGT OIL

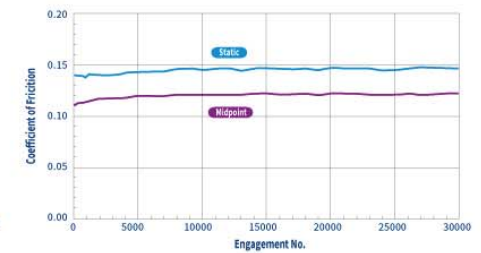

General Data

Recommended opposing surface: Steel up to 25 microinch Ra

Energy Capacity	210 J/cm ²	Max. Overload	6.9 Mpa
Power Capacity	115 W/cm ²	Avg. Dynamic Mu	0.110 - 0.140 oil dependent
Max. Continuous Load	5.5 Mp	Avg. Static Mu	0.140 - 0.160 oil dependent

S-156 BRONZE



Available in a range of thicknesses and oil groove patterns.

This material was developed as a premium transmission friction material where high coefficient of friction and high energy was a requirement. The material has excellent erosion resistance against oil cavitation with good load and wear resistance. Production applications include planetary, powershift and automatic transmissions and accessory clutches on earthmoving, ordnance and industrial equipment.

FRICITION VS SPEED SUZHOU BASELINE

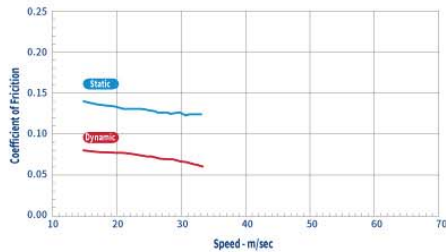

S156 DURABILITY TO-4 30WT. OIL

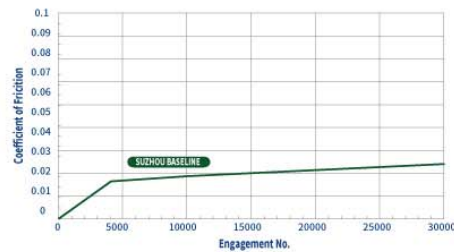

S-154 BRONZE



Available in a range of thicknesses and oil groove patterns.

This material was developed as a premium steer clutch /steer brake friction material where high coefficient of friction and long slipping times was a requirement. The material has excellent wear resistance at moderate energy conditions under long slip conditions which are encountered in many track type tractor applications. Production applications include steer clutch and steer brake modules and accessory clutches on earthmoving, ordnance and industrial equipment.

FRICITION VS SPEED SUZHOU BASELINE

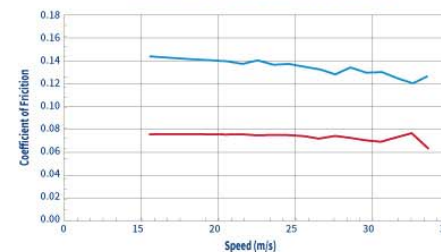

S154 DURABILITY TO-4 30WT. OIL

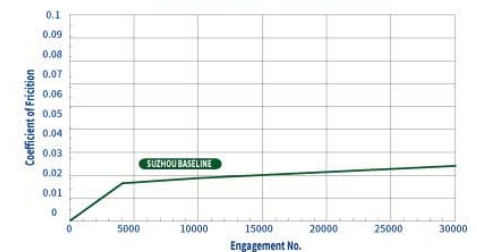

General Data

Recommended opposing surface: Steel up to 120 microinch Ra

Energy Capacity	150 J/cm ²	Porosity	12%
Power Capacity	85 W/cm ²	Median Pore Size	7.5 micron by volume
Max. Effective Rubbing Speed	35 m/s	Thermal Cond.	320 W/m-K@100°C
Max. Continuous Load	5600 kPa	Specific Heat	-
Max. Overload	8400 kPa	Modulus of Elasticity	-
Avg. Dynamic Coeff.	0.080 - 0.060 oil dependent	Poisson's Ratio	-
Avg Lock up Coeff.	0.150 - 0.130 oil dependent		

General Data

Recommended opposing surface: Steel up to 120 microinch Ra

Energy Capacity	120 J/cm ²	Porosity	10%
Power Capacity	75 W/cm ²	Median Pore Size	5 micron by volume
Max. Effective Rubbing Speed	30 m/s	Thermal Cond.	400 W/m-K@100°C
Max. Continuous Load	5600 kPa	Specific Heat	-
Max. Overload	8400 kPa	Modulus of Elasticity	-
Avg. Dynamic Coeff.	0.095 - 0.060 oil dependent	Poisson's Ratio	-
Avg Lock up Coeff.	0.170 - 0.130 oil dependent		

WET FRICTION PAPER APPLICATION TABLE

Wet Friction Application Questionnaire



FRICTION MATERIAL	ENERGY CAPACITY	MAX STATIC LOAD, MPA	MAX DYNAMIC LOAD, MPA	DYNAMIC* COEFFICIENT	STATIC* COEFFICIENT	TYPICAL APPLICATIONS	COMMENTS
N-266	Medium	8.4	5.6	0.110 to 0.140	0.150 to 0.190	Power shift transmission, Steer clutches and brakes, PTO	Low cost and good energy, able to withstand high unit loading and tolerate rougher opposing surfaces
N-269	High	8.4	5.6	0.110 to 0.150	0.170 to 0.250	Limited slip differentials, Load type clutches, Wet parking brake	High energy capacity with a positive lock up, good durability
N-360	Medium	3.9	2.5	0.120 to 0.150	0.150 to 0.190	Off highway mine truck brakes and loader brakes	Low cost and smooth engaging paper for low unit operating pressures
N-401	High	5.6	2.8	0.110 to 0.140	0.160 to 0.200	Power shift and counter shaft transmissions	High energy capacity with a positive lock up, good durability
N-414	Low	5.5	2.8	0.100 to 0.130	0.150 to 0.190	Steer clutch and brake for track type vehicles	Good material strength
N-420	Medium	5.5	2.8	0.120 to 0.140	0.150 to 0.170	PTO clutches	Good engagement characteristics
N-452	Medium	5.5	3.8	0.120 to 0.150	0.150 to 0.180	Off highway mine truck brakes and loader brakes	Ability to withstand higher unit operating pressures than N-360
N-611	Medium to High	5.6	4.2	0.110 to 0.150	0.150 to 0.180	Inboard and outboard brakes for construction and agricultural vehicles	Good friction stability and heat resistance, low noise
N-653	Medium to High	7.0	5.6	0.110 to 0.140	0.140 to 0.160	Premium candidate for any brake application	Good friction stability, heat capacity and pressure capability, low noise
N-670	Medium to High	11.7	5.6	0.110 to 0.140	0.140 to 0.160	Brake for loaders and off highway trucks transmission material for high heat systems	Good friction stability and heat capacity, Ability to withstand high unit operating pressures
TC-120	Very High	4.2	2.1	0.110 to 0.140	0.120 to 0.150	Brakes for loaders and military vehicle brakes and transmissions	Woven carbon cloth material for high energy applications, 0.81 mm wafer thickness, low noise
TC-121	Very High	4.2	2.1	0.110 to 0.140	0.120 to 0.150	Brakes for loaders and military vehicle brakes and transmissions	Woven carbon cloth material for high energy applications, 1.30 mm wafer thickness, low noise

*Coefficient of friction oil dependent.

SALES REP:

DATE:

CUSTOMER INFORMATION

Company Name:	Telephone:
Contact:	E-Mail:
Address:	Fax:

APPLICATION INFORMATION

Green color indicates required information

Clutch Pack Name:	Cooling Oil Type:
Friction Outside Diameter:	Cooling Oil Flow:
Friction Inside diameter:	Available hydraulic oil pressure:
Friction Core Thickness:	Piston area:
Friction Core Material:	Piston return spring force:
Opposing Plate Outside Diameter:	Maximum required dynamic torque:
Opposing Plate Inside Diameter:	Maximum required holding (static) torque:
Opposing Plate Thickness:	Maximum differential rpm before lock up:
Opposing Plate Material:	Slip time:
Opposing Plate Surface Finish:	Is "inching" required?:
Quantity of friction discs:	If inching then:
Quantity of opposing plates:	

EXPLANATION OF TERMS

A powershift transmission will have several different clutch packs. Usually they will be different in number of friction disks and often different in diameter. Therefore the designer of the transmission will give each pack a different designation/name. In addition since each pack is designed to handle different gears or speeds the operating conditions will differ among the packs.

A range clutch is a clutch pack that actuates quickly and only absorbs the energy of the transmission internals. A load/direction clutch absorbs much more energy in that it may absorb the kinetic energy of the whole machine as it reverses direction.

The Number of friction disks are needed to calculate the torque capacity of the clutch.

The Number of opposing plates are also needed to calculate the torque capacity

Friction Outside and Inside Diameters are needed to calculate the friction area, the surface pressure, and the mean torque radius

The friction core thickness and material data are needed to calculate the strength of the drive teeth and to a lesser degree the heat sink available.

Opposing plate thickness and material again are needed to calculate the strength of the drive teeth and much more importantly the short term heat sink.

The opposing plate surface finish in original equipment is a function of the friction material to be used. However, in the replacement market we must match the existing surface finish with an appropriate friction material. Most common units would be micro meters arithmetic average. Surface finish characterization is done many different ways and a full paper on this subject should be studied. Most importantly for friction materials is that deviations below the average line mean very little in regard to wear, but high sharp deviations above the line are very detrimental to paper friction materials.

Cooling oil type is extremely important because it has an extremely powerful effect on the coefficient of friction. It can change all aspects of the coefficient.

Cooling oil flow is the main method of removing heat from the pack. Although it does not remove large quantities of heat during the very short slip time of a range clutch, over the long slip times of a clutch in the inching mode or between engagements the several seconds to minutes with no slip it will cool the whole pack back to sump temperature.

The grooving configuration of the friction disk (multiple parallel, spiral-radial, sunburst, etc.) is often specified by the original equipment manufacturer. Sometimes, however, the OEM will ask for recommendations. We will suggest a configuration that will properly cool the stack and will be economical.

Available hydraulic pressure is the pressure of the hydraulic oil that is available to push on the back side of the piston that will apply the clutch. This will with the piston area determine the maximum force that can be applied to the clutch pack.

Piston area is needed in the calculation of the force that can be generated by piston to close the pack.

Piston return spring force is the force of the springs usually used to return the piston to the unapplied position and permit sufficient clearance between the friction disks and the opposing plates to minimize drag.

This is usually a small value and relatively hard to obtain. As such is often omitted from calculations. It is listed here for completeness.

Maximum required dynamic torque is the maximum torque required during the slipping condition, brought to zero speed difference.

Slip time is the number of seconds when the clutch pressure is applied and the input and output shafts are not at the same speed. This time is like the above dynamic torque based on a full zero speed engagement at the end of a shift.

Inching is a maneuver where a forklift operator has the ability to intentionally slip a clutch to permit the precise positioning of a load. In this case the slipping will be several seconds long and the speed difference between the input and output shafts will be nearly constant.

At the end of the slipping period the clutch is often totally disengaged.

The basic information on the inching slip (torque, oil flow, time of slip, and input to output rpm) is the same as for a full stop engagement except that the rpm and torque are usually constant throughout the slip.

COMMENTS

FAX: 0086 512 6805 0029 Email: CBF_AP_Marketing@carlislecbf.com

SALES REP:

DATE:

CUSTOMER INFORMATION

Customer:	Estimated potential sales and timing:
Address:	Phone:
Contacts:	Fax:
Title:	

APPLICATION DATA

Green color indicates required information

Loaded vehicle mass:	Friction discs outside and inside diameter:
Brake torque distribution:	Friction disks core thickness:
between RR and FR wheel:	Friction disks core material:
Number of the front/rear brakes:	Opposing plates thickness:
Rolling radius of the front (braked) wheels:	Opposing plates material:
Rolling radius of the rear (braked) wheels:	Opposing plates surface finish:
Number of friction discs per front brake:	Oil type:
Number of opposing plate per front brake:	Method of oil distribution (sump, bath or force fed):
Number of friction discs per rear brake:	Amount of oil available either liters/minute or if bath liters:
Number of opposing plate per rear brake:	Required stopping distance at specified velocity:
Total piston area per brake (front/rear):	Braking speed at required stopping distance:
Available hydraulic pressure:	Gear ratio between wheel and brake:

Other Comments & Data

COMMENTS

New Product

High Static Coefficient Paper

Description-High Static Coefficient Paper (Y-1292)

- Hydraulic Motor Lockup Brakes

CBF's Value Proposition

- 15% higher static coefficient than N-269
- Not for use in dynamic situations

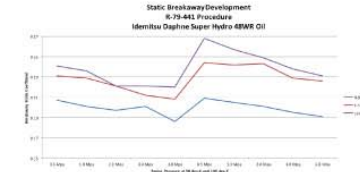

High Static Breakaway Update

Material development has been completed on a high static breakaway material. Static breakaway improvement has been observed compared to current Carlisle N269-4 material. Material development has exhibited similar breakaway static levels to the competitive material being used. Additional testing planned is evaluating different separator plate influences on the static breakaway.

XG Brake

Description

- Hydraulic Applied Service Brake

Targeted Applications

- Wheel Loaders
- To develop a better performance service brake with same mounting system

CBF's Value Proposition

- Select to use A4's components including high temp seal kits, better performance linings and pistons
- Optimized design for torque plate
- Target on 1500 hours without leakage



Bolt-On Wet Brake

Description

- Bolt-on wet brake and brake actuation system for mid-sized rigid dump trucks

Targeted Applications

- Mid-size rigid dump trucks (100T, 150T, 190T)

CBF's Value Proposition

- Off-highway brake development experience
- Wet friction product line
- Brake valve product line
- Opportunity to provide full brake system solution

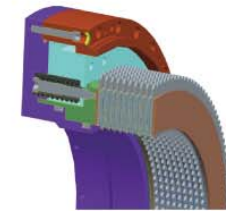

New Product

Electro-Hydraulic Brake Actuation System

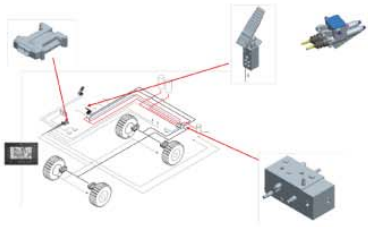

Description

- Hardware and software development for an electro-hydraulic brake actuation system for Liebherr's entire range of mining trucks. The system will be configured to support future requirements for ABS, traction control, and autonomous operation

Targeted Applications

- Mining Trucks

CBF's Value Proposition

- Take advantage of CBF existing technologies in:
 - Pedal and relay valves
 - Caliper Brakes
 - Wet Brakes
- Opportunity to provide full brake system solution with addition of electro-hydraulic actuation system

Ball on Ramp Actuators

Description

- Ball on Ramp Actuators for Agricultural Tractor

Targeted Applications

- Brake actuation for agriculture tractors from 35 to 90 HP range

CBF's Value Proposition

- CBF brand image
- Complete brake solution including hydraulic actuation
- Customized solution to customer requirement
- Wide product range



Quick Fill Master Cylinder

Description

- Quick Fill Master Cylinder with Integral Pedal Mount and Fluid Reservoir

Targeted Applications

- Backhoe Loaders

CBF's Value Proposition

- CBF brand image
- Complete pedal box assembly including patented booster

